

# Keyless Bushings

& SPECIALTY LOCKING DEVICES



**B-LOC**®

**Trantorque**®

# Fenner Drives B-LOC® & Trantorque® Keyless Bushings:

## Power and Precision

Fenner Drives, a worldwide leader in mechanical power transmission and motion control solutions, is pleased to present our comprehensive line of Keyless Bushings and Specialty Locking Devices. Only Fenner Drives delivers a product offering that combines the quick and easy installation of a Trantorque with the design flexibility and extra heavy duty capacity of a B-LOC.

Backed by North America's largest inventory of product ready for same-day shipment, the best customer service support in the industry, and the engineering expertise and manufacturing agility to provide custom solutions, Fenner Drives Keyless Bushings and Specialty Locking Devices always deliver on this promise: The key to better machine design is no key at all!



### **B-LOC Series B103** ..... page 18

- Shallow, single taper design with integrated push-off threads
- Exceptional concentricity and ability to transmit bending loads
- Limited axial movement during installation



### **Series B106** ..... page 20

- Shallow, single taper design with integrated push-off threads
- Exceptional concentricity and ability to transmit bending loads
- Use optional integrated spacer sleeve to mount narrow hub components
- No axial movement during installation



### **Series B112, B113 & B115** ..... page 26

- Wide, double taper design for enhanced bending moment capacity
- Exceptional concentricity with thru-bored hubs
- No axial movement during installation
- Available in Standard, Heavy and Extra-Heavy Duty models



### **Series B109** ..... page 17

- Designed for shafts as small as 1/4" or 6mm
- Shallow, single taper design with integrated push-off threads
- Exceptional concentricity and ability to transmit bending loads
- No axial movement during installation



### **Series 10, 20 & 30 Shrink Discs** ..... page 46

- External locking device
- Provides extremely concentric and well-balanced mechanical interference fit
- Offered in Standard, Light and Heavy Duty series
- Also available in Split and Half Shrink Disc designs



### **Series B400** ..... page 22

- Self-releasing, double taper design permits simple adjustment and removal
- Not self-centering. Available pilot bushings provide pre-centering when required
- No axial movement during installation



### **Series B800** ..... page 24

- Shallow, single taper design
- Exceptional concentricity
- Thin, extra wide sleeves provide low contact pressures allowing for smaller diameter hubs
- Integrated spacer sleeve eliminates axial movement during installation
- Minimal OD/ID ratio



### **WK Shaft Couplings** ..... page 48

- Rigid shaft coupling
- External locking device
- Transmits high torque and bending moments using the same principles as the Shrink Disc



**Trantorque® GT** ..... page 30

- Designed with external counter-torque flange
- Exceptional concentricity and ability to transmit bending loads
- Zinc plated for corrosion protection
- Limited axial movement during installation



**Trantorque Mini** ..... page 32

- Designed for shafts as small as 1/8" or 3mm
- Exceptional concentricity and ability to transmit bending loads
- Zinc plated for corrosion protection
- Limited axial movement during installation



**Trantorque OE** ..... page 34

- Exceptional concentricity and ability to transmit bending loads
- Limited axial movement during installation
- Minimal OD/ID ratio



**Trantorque OE Mini** ..... page 35

- Designed for shafts as small as 1/8" or 3mm
- Exceptional concentricity and ability to transmit bending loads
- Limited axial movement during installation



**Trantorque EN** ..... page 36

- Trantorque GT or Trantorque Mini with Electroless Nickel plating
- Corrosion protection in washdown and hostile environments
- Exceptional concentricity and ability to transmit bending loads
- Limited axial movement during installation



**Trantorque SS** ..... page 40

- Trantorque GT or Trantorque Mini manufactured from 303 Stainless Steel
- Ultimate corrosion protection in washdown and hostile environments
- Exceptional concentricity and ability to transmit bending loads
- Limited axial movement during installation



**Trantorque NT** ..... page 43

- Designed specifically to eliminate axial movement completely during installation
- Exceptional concentricity and ability to transmit bending loads
- Zinc plated for corrosion protection



**Trantorque S** ..... page 44

- Short units ideal for mounting narrow hub components
- Exceptional concentricity and ability to transmit bending loads
- Zinc plated for corrosion protection
- Limited axial movement during installation

**TABLE OF CONTENTS**

Traditional Connection Methods ..... 4  
 Why Go Keyless ..... 5  
 Selection Assistance ..... 6  
 Application Examples ..... 8  
 Made To Order (MTO) ..... 12

**B-LOC & TRANTORQUE**

Engineering Information — Keyless Bushings .. 14  
 Hub Sizing ..... 16  
 Technical Data — B-LOC ..... 17  
 Technical Data — Trantorque ..... 30  
 Engineering Information —  
 Specialty Locking Devices ..... 45  
 Technical Data — Shrink Discs ..... 46  
 Technical Data — WK Series ..... 48  
 Single Taper Shrink Discs &  
 Rigid Shrink Disc Couplings ..... 49  
 Trantorque Installation Wrenches ..... 50  
 Application Data Sheet ..... 51



# Fenner Drives Keyless Bushings & Specialty Locking Devices

From the moment the wheel came into existence, man has been faced with the seemingly simple task of mounting his invention to a shaft so that something useful could be accomplished. Though it has been over 5,500 years since these rotating components have made their way into use, many designs still utilize mounting methods not much improved from the days of antiquity. These traditional connection methods include: interference fits (shrink or press), keys and keyways, splines and quick detachable bushings. In the sections that follow, we compare and contrast these component mounting techniques and explain the principles behind the ingenious Fenner Drives Keyless Bushing.

## Traditional Connection Methods

### Interference Fits (Shrink and Press)

A shrink fit is a procedure whereby heat is used to facilitate a mechanical interference fit between two pieces of metal, such as a steel shaft and hub. Extreme heat is applied to the hub, causing it to expand and increasing the size of its machined bore. The expanded hub is removed from the heat source and quickly positioned onto the shaft. As the hub cools, its bore contracts back to its original machined dimension, effectively “shrinking” the hub onto the shaft.

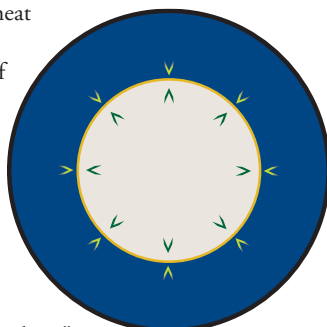

Shrink/Press

A press fit achieves the same end as a shrink fit — a mechanical interference fit between a steel shaft and hub — but does so through different means. Press fits rely on the application of simple brute force to “press” the hub onto the shaft.

Interference fits offer several advantages, such as zero backlash and uniform fit pressures, but these advantages come at a price. High capacity interference fits require long fit lengths, close tolerances, expensive and sometimes hazardous heat sources or hydraulic presses, and field maintenance is extremely difficult. Finally, separated components can rarely be re-used.

### Keys, Keyways & Splines

The centuries-old industry standard shaft-to-hub mounting technique is the key and keyway. While ubiquitous and intuitively easy to understand, the key and keyway is a remarkably ineffective technology. Machining a keyway into a shaft is not inexpensive, nor is the equipment required to do so, though these costs are often unknown or overlooked. Keyways introduce notch factors, which account for the reduced effective cross section and abridged fatigue life that occurs when a shaft is keyed and lead, in turn, to systematic over-sizing of shaft diameters. This translates to more shaft material and weight, larger bearings and other drive components, and increased cost.

Further, keyed connections require fit clearance for assembly, both between key and keyway and between shaft and hub.

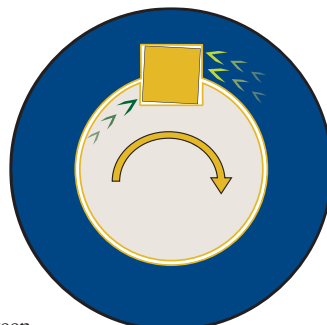

Key & Keyway

The combined effect of these clearances is backlash. In applications with frequent starts/stops, direction changes, and/or shock overloads, this backlash can lead to pounded out keyways, fatigue failures, fretting corrosion or some combination of these failure modes. Nor do keys and keyways lend themselves to motion control applications, since backlash erodes the accuracy of motion profiles over time.

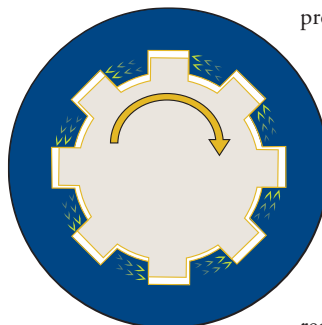

Spline

A splined connection is simply a series of keys and keyways that suffers the same limitations and drawbacks associated with a single keyed connection. Manufacturing costs are high, especially on hollow shafts, and special surface treatment is often required to increase strength.

### Keyed Bushing Systems

Both QD and Taper-Lock® bushing and weld-on hub systems are popular component mounting technologies. Yet both are ultimately keyed connections and as a result suffer from the same operational drawbacks as described above. As their name indicates, the weld-on hubs require an additional, and expensive, manufacturing step. And while the bushings can be used without a weld-on hub, doing so requires machining a taper and drilling and tapping holes in the mating part.

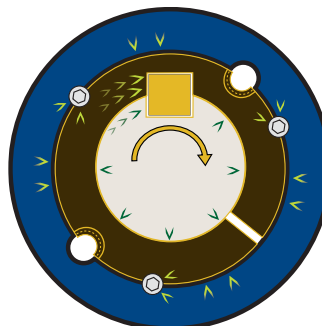

Taper-Lock

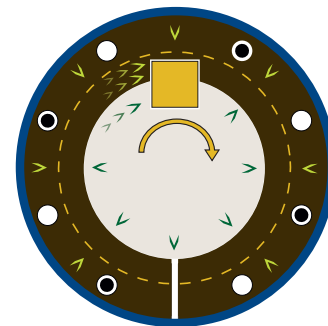

QD



# Why Go Keyless

Today's global marketplace demands precise, efficient machines that optimize productivity while minimizing material and fabrication costs. When compared to traditional connection methods, Fenner Drives Keyless Bushings offer the following advantages:

- A mechanical interference fit with a uniform pressure distribution similar to that achieved through a shrink or press fit.
- A true zero backlash shaft-to-hub connection with none of the operational drawbacks of keyways or splines.
- The ability to mount on plain shafting, which need not be over-sized to compensate for notch factors. This allows the use of smaller shafts and bearings for more cost effective designs.

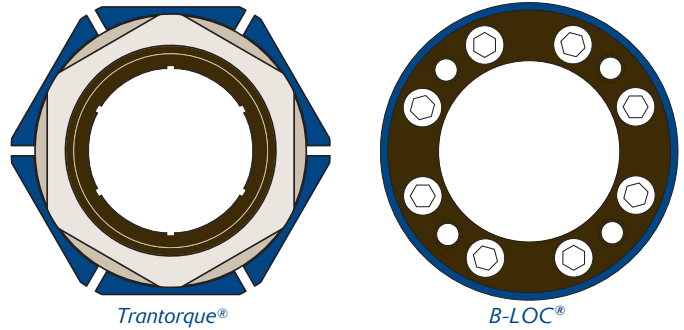

- The flexibility to mount over existing keyways if desired.
- Straight bore machining of the mounted component, generous machining tolerances and as-turned surface finishes.
- Complete axial and radial adjustability.
- Simple installation, adjustment and removal, even in the field.

## Principles of Operation

Though offered in many shapes and sizes, Fenner Drives Keyless Bushings and Specialty Locking Devices all operate using the simple wedge principle. An axial force is applied — by either a hex nut or a series of annular screws — to engage circular steel rings with mating

tapers. In the case of keyless bushings, the resulting wedge action creates a radial force on the tapered rings, one of which contracts to squeeze the shaft while the other expands and presses into the component bore.

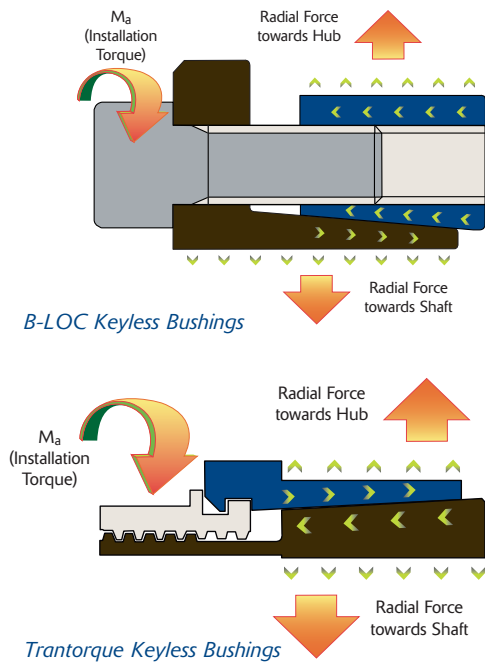

In the case of specialty locking devices, similar tapered geometry generates a radial force that is concentrated (in the case of our Shrink Discs) around a solid steel hub, squeezing so tightly that the hub “shrinks” onto the underlying shaft, or (in the case of our WK Series Couplings) simultaneously onto two solid shaft ends to form a high-capacity rigid coupling.

In all cases, the product of the radial force applied to the shaft, the radius of that shaft and the coefficient of friction between the surfaces being joined equals the rated torque capacity of the connection.

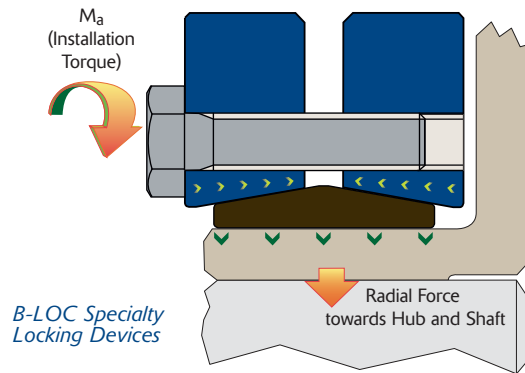

Comparison Chart	B-LOC	Trantorque	Interference Fit	Keyed Connection	Splined Connection	QD or TL Bushings
Keyless frictional connection	✱	✱	•			
Infinite radial and axial adjustment	✱	✱				
Easy installation	✱	✱		•	•	•
Easy removal	✱	✱				•
Backlash free connection	✱	✱	•			
Transmits shock and torque reversals	✱	✱	•			
Transmits reversing bending moments	✱	✱	•			

## B-LOC® or Trantorque®: the Enduring Question

Once you have decided that a keyless bushing is the right solution, your next big decision is which series of Fenner Drives B-LOC or Trantorque Keyless Bushings to choose. While the underlying engineering principle for both B-LOC and Trantorque Keyless Bushings is exactly the same, the functionality of each may appeal to different applications and situations.

SELECTION ASSISTANCE	Shaft Size Range	Torque Transmission	Axial Movement	Self Centering	Concentricity	Balance	Self-Locking Tapers
<b>B-LOC B109</b>	¼ – 1 ½ in; 6 – 35mm	167 – 5,929 in lb; 19 – 683 Nm	No	Yes	Excellent	Excellent	Yes
<b>B-LOC B103</b>	¾ – 8 in; 15 – 400mm	247 – 48,913 ft lb; 115 – 489,701 Nm	~0.032 in (0.8mm)	Yes	Excellent	Excellent	Yes
<b>B-LOC B106</b>	⅝ – 8 in; 14 – 400mm	55 – 37,959 ft lb; 68 – 372,590 Nm	No	Yes	Excellent	Excellent	Yes
<b>B-LOC B400</b>	¾ – 8 in; 18 – 500mm	234 – 53,827 ft lb; 302 – 814,734 Nm	No	No	Fair	Very Good	No
<b>B-LOC B800</b>	¼ – 4 1/16 in; 6 – 130mm	16 – 18,362 ft lb; 22 – 25,742 Nm	No	Yes	Excellent	Excellent	Yes
<b>B-LOC B112</b>	1 – 8 in; 24 – 600mm	600 – 110,469 ft lb; 755 – 1,756,139 Nm	No	Yes	Excellent	Excellent	Yes
<b>B-LOC B115</b>	2 ¾ – 8 in; 70 – 600mm	5,261 – 70,109 ft lb; 7,118 – 1,228,856 Nm	No	Yes	Excellent	Excellent	Yes
<b>B-LOC B113</b>	180 – 560mm	223,566 – 2,342,897 Nm	No	Yes	Excellent	Excellent	Yes
<b>Trantorque GT</b>	⅝ – 3 in; 15 – 75mm	146 – 1,500 ft lb; 180 – 2,000 Nm	~0.075 in (1.9mm)	Yes	Excellent	Excellent	Yes
<b>Trantorque Mini</b>	⅛ – ¾ in; 3 – 17mm	100 – 1,500 in lb; 12 – 170 Nm	~0.045 in (1.1mm)	Yes	Excellent	Very Good	Yes
<b>Trantorque OE</b>	1 1/16 – 1 ½ in; 17 – 35mm	158 – 483 ft lb; 208 – 645 Nm	~0.075 in (1.9mm)	Yes	Excellent	Excellent	Yes
<b>Trantorque OE Mini</b>	⅛ – ⅝ in; 3 – 16mm	62 – 1,184 in lb; 7 – 135 Nm	~0.045 in (1.1mm)	Yes	Excellent	Very Good	Yes
<b>Trantorque EN</b>	⅝ – 3 in; 15 – 75mm	73 – 750 ft lb; 90 – 1,000 Nm	~0.075 in (1.9mm)	Yes	Excellent	Excellent	Yes
<b>Trantorque EN Mini</b>	⅜ – ¾ in; 5 – 17mm	50 – 750 in lb; 6 – 85 Nm	~0.045 in (1.1mm)	Yes	Excellent	Very Good	Yes
<b>Trantorque SS</b>	⅝ – 3 in; 15 – 75mm	44 – 450 ft lb; 54 – 600 Nm	~0.075 in (1.9mm)	Yes	Excellent	Excellent	Yes
<b>Trantorque SS Mini</b>	⅜ – ¾ in; 5 – 17mm	30 – 450 in lb; 4 – 46 Nm	~0.045 in (1.1mm)	Yes	Excellent	Very Good	Yes
<b>Trantorque NT</b>	⅜ – 2 in	6 – 817 ft lb	No	Yes	Excellent	Very Good	Yes
<b>Trantorque S</b>	⅜ – 1 ¾ in	8 – 833 ft lb	~0.075 in (1.9mm)	Yes	Excellent	Very Good	Yes
<b>Shrink Discs</b>	⅝ – 17 ¾ in; 15 – 440mm	139 – 1,749,331 ft lb	No	Yes	Excellent	Excellent	No

## Internal or External

At the broadest level, the product line may be split into two categories, Keyless Bushings (internal) and Specialty Locking Devices (external). Selection among Specialty Locking Devices is relatively straightforward. If you are joining two solid shafts at their ends, see page 48 for details on our B-LOC WK Series Rigid Couplings. To connect most industry standard coupling hubs or flanges, gearboxes with hollow output shafts, or certain other similarly configured power transmission components, a B-LOC Shrink Disc may be best suited; see page 45.

Most applications, however, consist of a shaft and bored component that require the use of a keyless bushing. Many more factors play into the proper selection of a keyless bushing and are briefly addressed below and in the accompanying table.

Corrosion Treatment	Recessed Installation Without Counterbore	Overall Length Range	RoHS Compliant
Machine Oil	No	0.650 – 1.102 in; 16.5 – 28.5mm	Yes
Machine Oil	Yes	1.122 – 2.559 in; 21.5 – 116mm	Yes
Machine Oil	No	0.846 – 2.559 in; 20.5 – 116mm	Yes
Machine Oil	Yes	0.787 – 2.047 in; 20 – 102mm	No
Machine Oil	No	0.866 – 5.039 in; 22 – 128mm	Yes
Machine Oil	Yes	1.575 – 5.866 in; 40 – 203mm	Yes
Machine Oil	Yes	2.441 – 4.134 in; 62 – 160mm	Yes
Machine Oil	Yes	231 – 280mm	Yes
Zinc Plating	No	1½ – 4¼ in; 38.1 – 108mm	Inch - No Metric - Yes
Zinc Plating	No	¾ – 1¾ in; 19.1 – 34.9mm	Inch - No Metric - Yes
Machine Oil	No	1¾ – 1⅞ in; 30 – 44mm	Yes
Machine Oil	No	¾ – 1½ in; 19 – 29mm	Yes
Electroless Nickel Plating	No	1½ – 4¼ in; 38.1 – 108.0mm	Yes
Electroless Nickel Plating	No	¾ – 1¾ in; 19.1 – 34.9mm	Yes
Stainless Steel Construction	No	1½ – 4¼ in; 38.1 – 108.0mm	Yes
Stainless Steel Construction	No	¾ – 1¾ in; 19.1 – 34.9mm	Yes
Zinc Plating	No	1⅞ – 4¾ in	Inch - No Metric - Yes
Zinc Plating	No	⅝ – 1½ in	No
Zinc or Chrome Plating	N/A	0.71 – 10.79 in; 22 – 292 mm	No

## Shaft Size

Shaft size may immediately determine whether you use a B-LOC or Trantorque Keyless Bushing. A Trantorque can accommodate shaft sizes as small as 1/8" while the smallest shaft a B-LOC will fit is 1/4". At the other end of the spectrum, Trantorque tops out at 3" and the largest B-LOC will accommodate shafts approaching 24". Larger and smaller versions of all units may be available as MTOs (Made To Order).

As a practical matter, under most circumstances our Applications Engineers will recommend a Trantorque for shaft sizes 1-1/2" and under and a B-LOC for shaft sizes 2" and over. These are considered the optimal ranges for the product lines, taking maximum advantage of each product's unique installation method. Between these ranges, selection will most likely be driven more by other application factors.

## Installation

The most obvious difference when comparing a B-LOC to a Trantorque Keyless Bushing is the installation method. All B-LOC units use a plurality of screws; all Trantorque units use a single hex nut. Your particular application will be your guide as to which method is preferred.

The advantages of a single hex nut, as used in a Trantorque Keyless Bushing, are speed and simplicity of installation and removal. For installation, simply tighten the single hex nut to the specified installation torque and your connection is complete. Removal is just as straightforward. Merely loosen the same hex nut and the unit will disengage. The cost for this simplicity is a relatively high installation torque requirement, which may present a challenge for larger units.

Since the force needed to draw the mating tapers of a B-LOC Keyless Bushing together is distributed among many screws, the installation torque of an individual screw is relatively low. This allows for effortless installation of even the largest units. The price paid for this low installation torque is a more timely and complex installation and removal process. The screws must be slowly and equally tightened in series until the final installation torque is achieved. Since most B-LOC units have self locking tapers, the removal process requires removing all screws and jacking the unit apart.

## Other Considerations

There are several other design points that may help guide you in your selection process. OD to ID ratios vary widely from product to product. If your design requires a small OD/ID ratio, consider either a B-LOC B800 or a Trantorque OE. While all Fenner Drives Keyless Bushings are designed to transmit high torque loads, if you have an extremely demanding application, a double taper B-LOC B112, B113 or B115 may be required. If you are mounting plate sprockets or other thin components, a Trantorque S could be the solution. Other factors to consider include axial movement, recessed installation, corrosion protection, and RoHS compliance. The table is designed to help make your selection process easier, but if you are ever in doubt, please contact a Fenner Drives Applications Engineer. We will be happy to guide you to the perfect keyless bushing solution.

# Fenner Drives Keyless Bushings & Specialty Locking Devices

From precision medical devices to powerful turbines, Fenner Drives Keyless Bushings are

perfectly suited for use in any industry where there is a need to mount a component to a shaft.

Every day, our customers find unique uses for the engineering elegance of our keyless bushings.

The application examples shown are just a small sampling of the many thousands of possible applications for Fenner Drives Keyless Bushings. So ask yourself, "What do I need to mount today?"

## B-LOC®

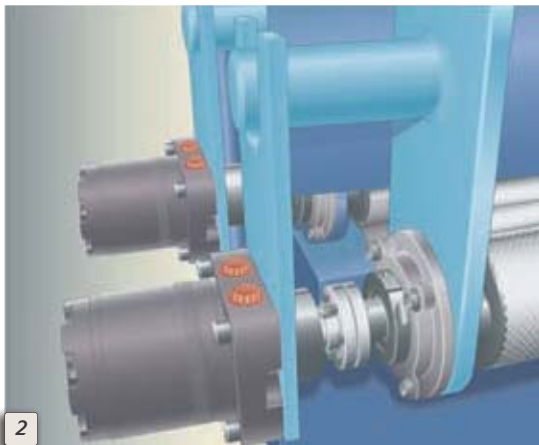
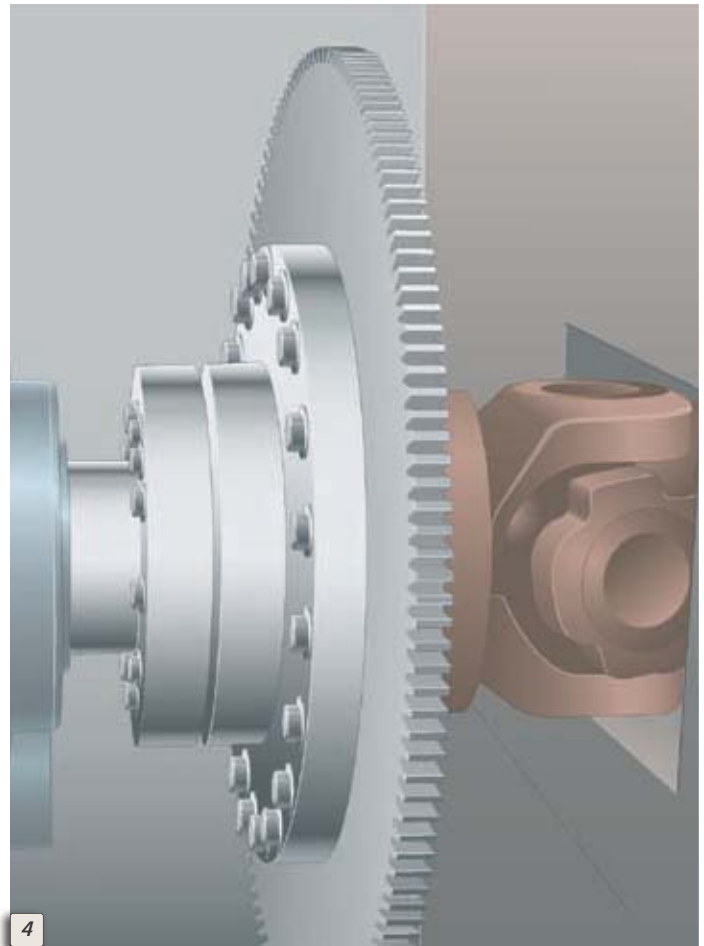
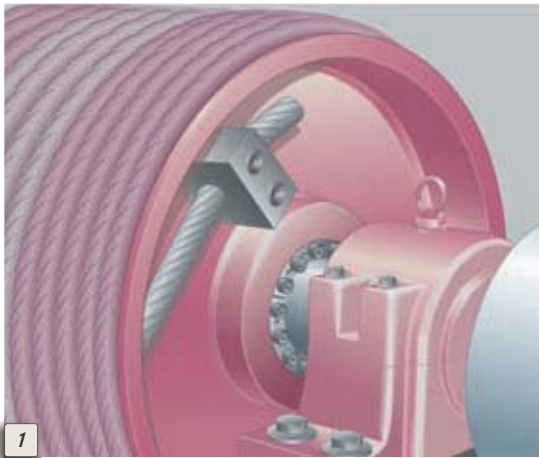
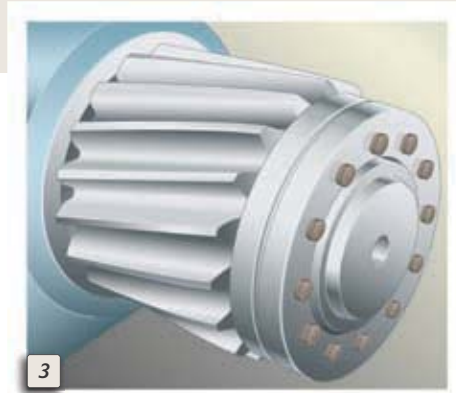

- 1 Heavy Duty B112 connects large draw works drum on offshore oil platform.
- 2 B-LOC Shrink Discs and WK Series Rigid Couplings facilitate torque-arm mounting of hydraulic drives directly onto the driven shaft, eliminating more expensive and less reliable flexible coupling arrangements.

- 3 Standard Duty Shrink Disc holds precision pinion gear on mechanical stamping press.
- 4 Heavy Duty Shrink Disc connects positive drive u-joint flange on coal plant pre-heater.



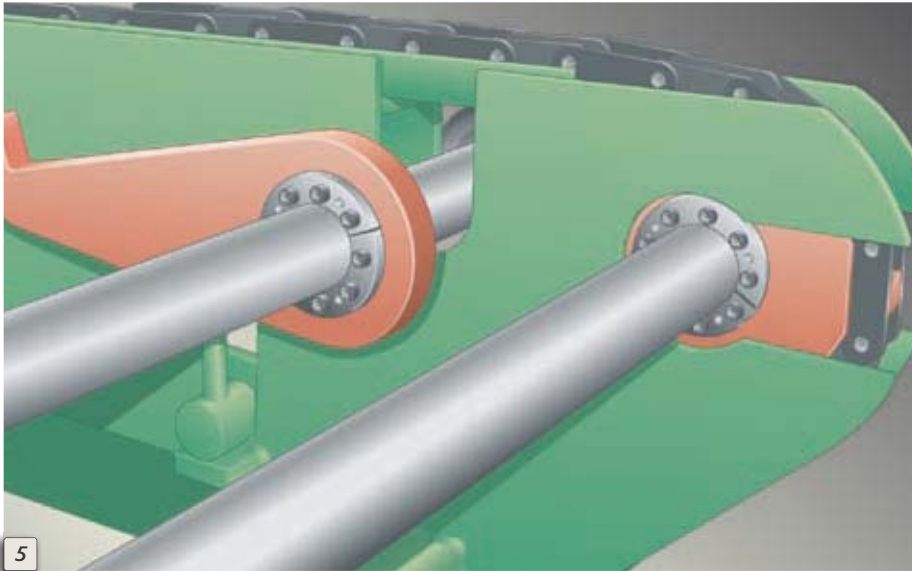

5

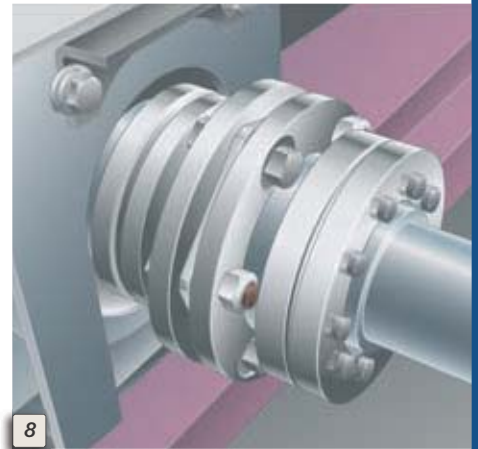

8

5 B106 connects mill chain sprocket and permits simple timing of matched kicker arms on wood processing infeed table.

6 Standard Duty Shrink Disc simultaneously transmits torque and thrust as standard shaft/hub connection specified on revolutionary air-gap magnetic coupling.



6

7 Heavy Duty B112 mounts rotor on an aggregate impact crusher.

8 Standard Duty Shrink Disc provides zero backlash connection for flexible disc coupling on packaging equipment.

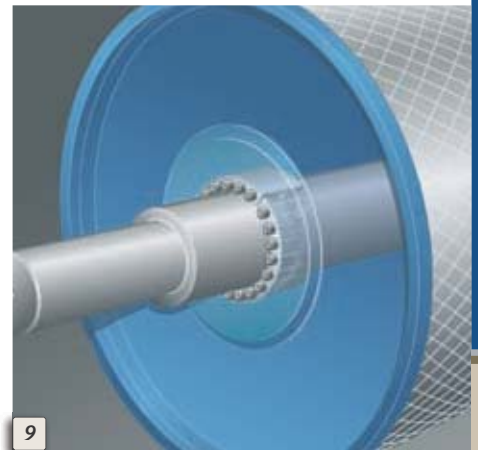

9

9 Medium Duty B115 integrates with modern engineered class pulley design to maximize operating life (transparent view).

10 Heavy Duty B112 used to mount and set backlash on mating gears driving low speed, high torque augers on a large volume mixer/dryer.

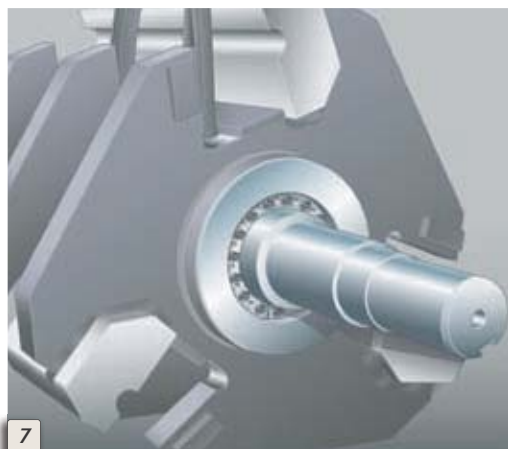

7

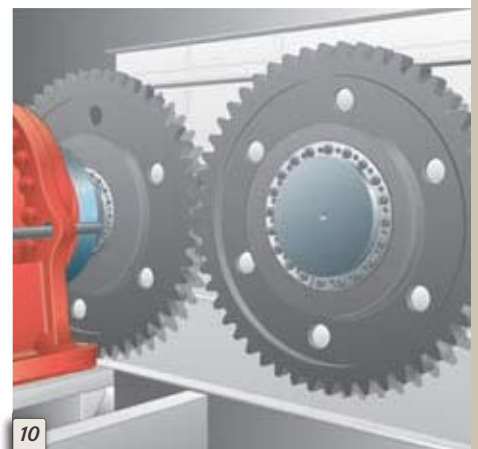

10

# Trantorque®

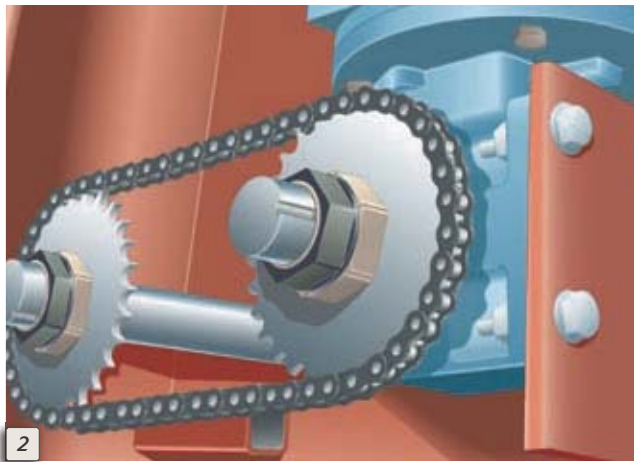
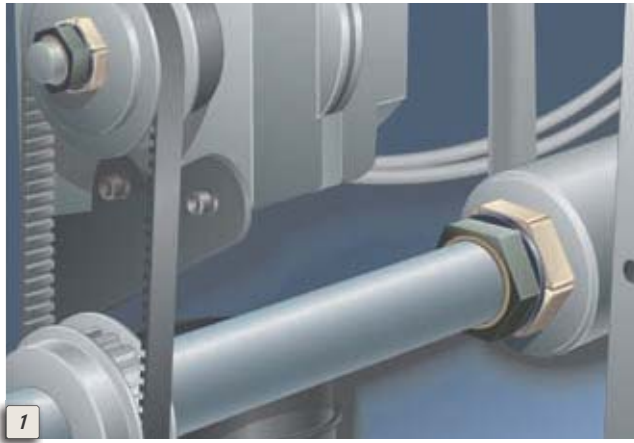

- 1 Trantorque GT connects a timing pulley to shaft on a canning machine.
- 2 Trantorque GT mounts a roller chain sprocket to a keyless reducer output shaft.
- 3 Trantorque GT connects a synchronous belt pulley to rear wheel of hybrid vehicle (transparent view).
- 4 Trantorque OE ensures zero backlash on a rack and pinion drive.
- 5 Trantorque Mini provides a solution for mounting components in tight spaces on very small shafts, such as for this timing pulley on a linear slide.

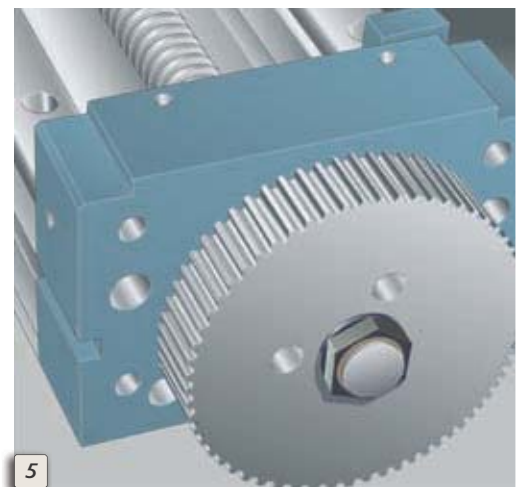



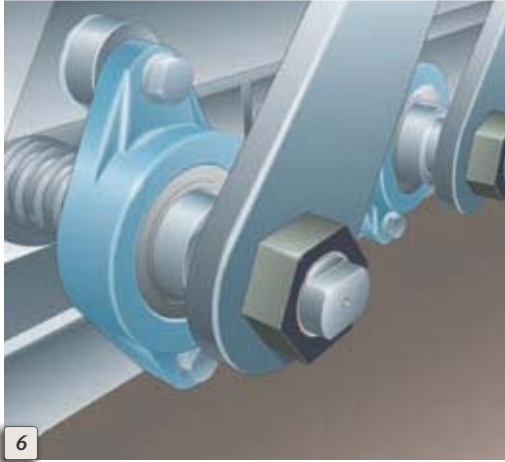

6



8



7

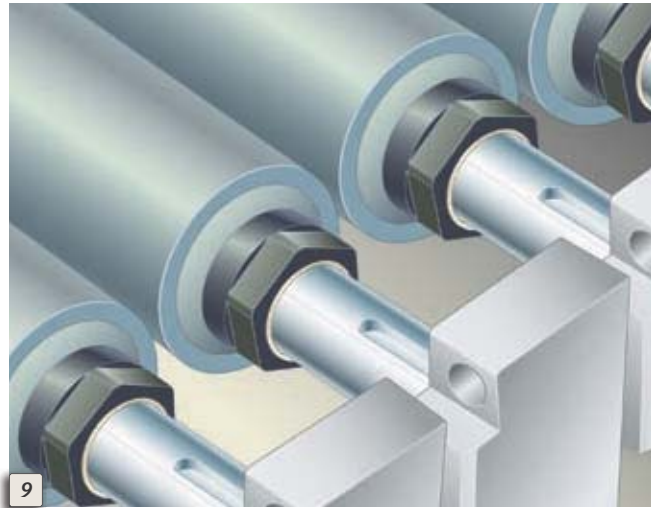

9

- 6 Trantorque S positions a series of lever arms, greatly simplifying installation and timing.
- 7 The Trantorque GT units on this battling robot allowed the designers to eliminate keys and keyways, resulting in a lighter yet stronger machine.
- 8 Trantorque GT is perfect for high speed, low torque applications where balance is critical, as on this fan hub.
- 9 Trantorque NT allows worn conveyor rolls to be replaced quickly and easily.
- 10 This Trantorque GT — like all of our keyless bushings — features infinite radial positioning, making timing of this run-out table chain drive quick and easy.

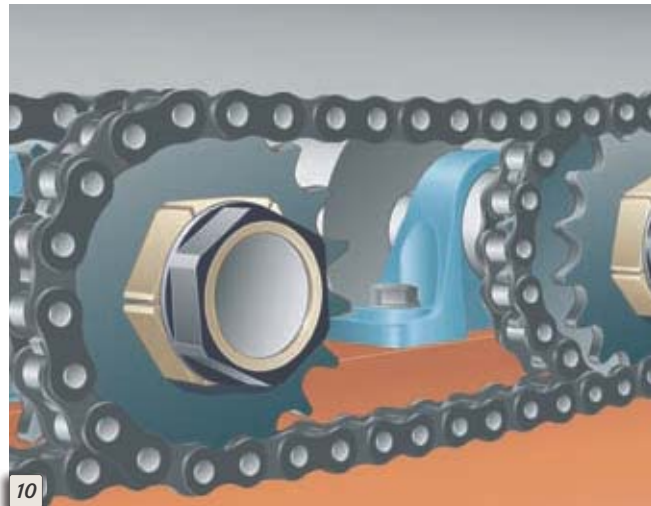

10

Application Illustrations by Mick Hill

## Made to Order (MTO)

Fenner Drives offers a wide selection of standard keyless bushings to meet most shaft/component mounting needs. However, we realize that to be innovative in a global marketplace, today's engineers often require custom solutions. With unrivaled engineering expertise in keyless bushing design and material selection coupled with world class manufacturing capabilities, Fenner Drives is well positioned to offer MTO Keyless Bushings. From the ordinary to the extraordinary, our engineering team is ready to work with you. Together, we will develop a unique keyless bushing to meet your most demanding shaft/component mounting challenges.

Following are examples of some MTO building blocks that Fenner Drives has experience designing and working with. If you have an even more complex application, Fenner Drives New Product Development Group is ready to innovate with you.

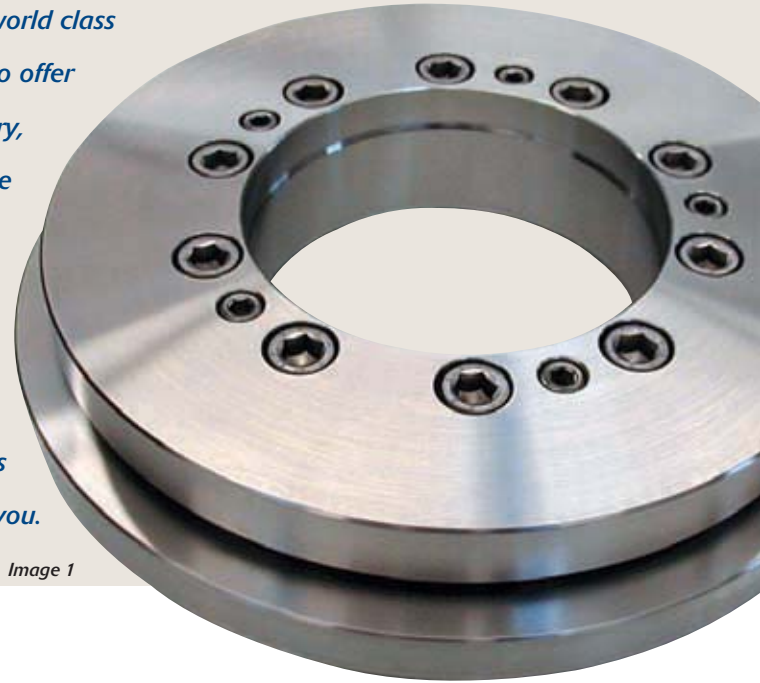

Image 1



Image 2

### Special Materials

All standard keyless bushings, with the exception of Trantorque SS, are made from either carbon or low-alloy steels. Certain applications may require the use of other materials such as:

- Stainless steel
- EXP stainless steel (allows for higher torque transmission without the use of lubricants)
- Brass
- Tool steel

### Platings/Coatings

Special platings or coatings may be appropriate to deal with specific environmental or performance needs.

- Electroless (chemical) nickel with PTFE
- Zinc
- TDC (Thin Dense Chromium)
- Zinc and aluminum in inorganic binder (water-based, VOC compliant)



Image 3

**Image 1:** This MTO Half Shrink Disc was designed with recessed installation and removal screws and is fabricated entirely of Stainless Steel.

**Image 2:** This Trantorque® MTO was designed for a blood centrifuge that required daily disassembly for cleaning and disinfecting. The knob allows easy disassembly without the use of tools.

**Image 3:** Shown actual size, this Trantorque MTO incorporates an extremely narrow clamping section that precisely matches the mounted component.



## Lubricants

The use of lubricants on threads and in some special cases, tapers, can have dramatic impact on keyless bushing properties.

- Light machine oil
- Synthetic grease
- FDA approved lubricants

## Screws

Performance of many B-LOC™ Keyless Bushings is determined by the screw grade used. Additionally, particular applications may benefit from a custom screw configuration.

- 12.9 and 10.9 socket head cap screws
- 10.9 hex head cap screws
- Fewer screws
- Smaller screws



Image 4

## Designs

In addition to special materials, coatings, lubricants and fasteners that can be used with existing designs, the B-LOC and Trantorque® fundamental architecture can be radically modified for special applications.

- Hand knobs in place of nuts on Trantorque Keyless Bushings
- Keyless bushings integrated into customer components
- Lips/flanges
- Grooves
- Common OD with differing ID series
- Non-standard IDs and ODs
- Long units
- Short units



Image 5



Image 6

**Image 4:** This MTO Shrink Disc illustrates our ability to expertly design and manufacture special products for any size application, large or small.

**Image 5:** A positioning flange is machined both inside the bore and at the back of the outer clamping ring on this Trantorque MTO. The flanges guarantee perfect positioning when components are manipulated in the field.

**Image 6:** Our Applications Engineers' penetrating knowledge of keyless bushing technology allows them to design MTO products to uniquely satisfy customer demands.

[www.fennerdrives.com](http://www.fennerdrives.com)

**To facilitate working with our Applications Engineering Group on MTOs, please complete the Application Data Worksheet on page 51.**

## SURFACE FINISH

Recommended surface finish for shafts and hub bores to be used with Fenner Drives Keyless Bushings is between 32 and 125 micro-inch RMS. A smoother finish — such as that found on components supplied TG&P (turned, ground and polished) — is NOT recommended and can result in a failure of the connection. Note that surface finishes below 32 micro-inch RMS can be roughened using longitudinal abrasion with a bastard file, emery paper or similar to achieve a surface finish within the recommended range.

## CONCENTRICITY

Fenner Drives Keyless Bushings are precision machined to maximize concentricity and minimize runout. The final installed concentricity of mounted components depends on several variables, including the components themselves and the installation technique employed. Special attention to proper installation will be required for B-LOC® B400 series units. Overall, however, concentricity is typically excellent for the majority of Fenner Drives Keyless Bushings.

## SYNTHETIC DRIVE COMPONENTS

Fenner Drives Keyless Bushings are not recommended for use with most drive components constructed of synthetic polymers. An exception can be made if the component incorporates a reinforcing metal sleeve of sufficient size and strength. Please consult a Fenner Drives Applications Engineer regarding such applications.

## TEMPERATURE INFLUENCE

Similar to conventional shrink or press fits, connections using Fenner Drives Keyless Bushings are not affected by temperature changes as long as they apply equally to shaft and mating hub. Since temperatures above 400°F or 204°C lower the strength of most commonly used materials, special considerations are necessary for connections working in temperatures exceeding 400°F or 204°C.

## MOUNTING BEARINGS WITH FENNER DRIVES KEYLESS BUSHINGS

Mounting bearings with a Fenner Drives Keyless Bushing is not recommended. The expansion forces generated will distort the bearing's inner race, causing premature failure.

## INSTALLING MULTIPLE FENNER DRIVES KEYLESS BUSHINGS IN SERIES

Additional torque capacity can be achieved by arranging two or more B-LOC Keyless Bushings in series. In these situations, where access to locking screws is available from one side only, the total torque capacity of the connection is not a linear function of the number of units applied. For applications involving B-LOC Keyless Bushings in series, please consult with a Fenner Drives Applications Engineer.

## ANAEROBIC ADHESIVES (THREADLOCKER)

Do not use anaerobic adhesives such as Loctite®, Permatex® or similar compounds with Fenner Drives Keyless Bushings. Doing so results in unknown contact pressures and capacities. Further, disassembly may be compromised when such compounds are applied to the keyless bushing, the shaft and/or the hub bore. Proper installation assures sufficient pre-load so that threads are self-locking, even in cases where the keyless bushing is subjected to extreme vibratory conditions.

## HOLLOW SHAFTS

Hollow shafts with bores exceeding 35% of outside diameter usually require a reduction of contact pressures in order to avoid permanent shaft deformation. Special considerations arise when installing Fenner Drives Keyless Bushings onto hollow shafts. Please consult with a Fenner Drives Applications Engineer for a trouble free hollow shaft connection.

## LUBRICANTS

Trantorque® OE, OE Mini Series and B-LOC Keyless Bushings are supplied unplated and lightly coated with ordinary machine oil. All other Trantorque units are supplied free of lubricant.

## MATERIALS

Trantorque Keyless Bushings are manufactured from carbon steel. B-LOC Keyless Bushings are manufactured from heat treated high-carbon and alloy steels. For applications in corrosive environments, corrosion resistance can be improved through sealing with grease or silicone, the use of protective cover plates, application of industry standard plating materials (e.g., nickel, thin dense chromium, etc.) or by specifying the product in stainless steel (such as Trantorque SS) or other corrosion resistant materials. Please consult with a Fenner Drives Applications Engineer for more details.

## TORQUE

T = peak drive torque = nominal torque multiplied by a variable safety factor to account for stall or start-up conditions, mass accelerations, impact loads, etc. Nominal drive torque can be calculated as follows:

$$M_{t_{nom}} \text{ (ft lb)} = \frac{5252 \times \text{HP}}{\text{rpm}}$$

$$M_{t_{nom}} \text{ (Nm)} = \frac{9550 \times \text{kW}}{\text{rpm}}$$

Consult with a Fenner Drives Applications Engineer in cases where “T” is uncertain.

$M_t$  = The rated torque capacity of one Fenner Drives Keyless Bushing installed according to our instructions. Published torque capacities are calculated without using a safety factor and should be considered as the point where a connection could slip if a higher torque is applied. Therefore, always select a unit where  $M_t \geq T$ .

## MODIFIED INSTALLATION TORQUE

Torque capacity and contact pressures are a linear function of locking screw/hex nut tightening torque ( $M_a$ ) and can be adjusted if necessary by changing  $M_a$  within the following limits:

Series	$M_a$
B-LOC B103/B106/B109	up to 20% lower
B-LOC B400	up to 20% higher or up to 20% lower
B-LOC B800	up to 20% lower
B-LOC B112/B113	up to 40% lower
B-LOC B115	up to 30% lower
Trantorque	up to 20% lower

## THRUST

$T_h$  = transmissible thrust, determined by using the following equation:

$$T_h = \frac{2 \times M_t}{d}$$

where:  $d$  = shaft diameter

$M_t$  = unit torque rating

## TORQUE AND THRUST COMBINED

Simultaneous transmission of torque and thrust requires calculating a resultant torque:

$$M_{t_{res}} = \sqrt{T^2 + \left(\frac{F \times d}{2}\right)^2}$$

where:  $T$  = peak drive torque

$F$  = peak thrust load

$d$  = shaft diameter

Select a unit where  $M_t \geq M_{t_{res}}$ .

## BENDING MOMENTS

Bending moments are a crucial sizing factor in applications where a radial load from chain pull, the weight of components, etc. acts significantly outside the keyless bushing centerline. Typical applications include rolls or conveyor pulleys where shaft deflection due to radial loads results in a bending moment between shaft and end disc. Generally, bending moments change from a positive to a negative value during each rotation and are designated as rotating or reversing bending moments.

Fenner Drives Keyless Bushings are well suited to transmit rotating/reversing bending moments. Compiled using relevant data gleaned from numerous successful heavy-duty applications in conveyor pulleys as well as pertinent investigations by independent institutions, the following bending moment capacities apply:

Series	Bending Moment Capacity
B-LOC B103/B106/B109	$0.28 \times M_t$
B-LOC B400	$0.22 \times M_t$
B-LOC B800	$0.28 \times M_t$
B-LOC B115	$0.32 \times M_t$
B-LOC B112/B113	$0.35 \times M_t$
Trantorque	$0.28 \times M_t$

where:  $M_t$  = Rated torque capacity (from specification tables)

Consult with a Fenner Drives Applications Engineer on applications where the actual bending moment exceeds these recommended limits.

## TORQUE AND BENDING COMBINED

Simultaneous transmission of torque and bending requires calculating a resultant torque:

$$M_{tb} = \sqrt{T^2 + (2 \times M_b)^2}$$

where:  $T$  = peak drive torque

$M_b$  = bending moment

Always select a unit where  $M_t \geq M_{tb}$  and  $M_b$  is within the limits appearing under **Bending Moment Capacity** above.

## FENNER DRIVES KEYLESS BUSHINGS WITH SHAFT ADAPTOR SLEEVES

When an existing shaft diameter does not fit the bore of a standard Fenner Drives Keyless Bushing, we recommend using an adapter sleeve that can be sized to allow for the use of a standard unit and the existing shaft. The maximum wall thickness of the adapter sleeve should be approximately 10% of the existing shaft diameter.

Note that in order to maximize the torque capacity of a sleeved keyless bushing connection, the shaft/sleeve bore interface must be free of any lubricant. This makes the sleeve outside diameter/keyless bushing bore the point of lowest torque capacity (provided the sleeve outside diameter is less than 1.25 times the shaft diameter) and allows for full use of the larger keyless bushing's higher torque capacity.

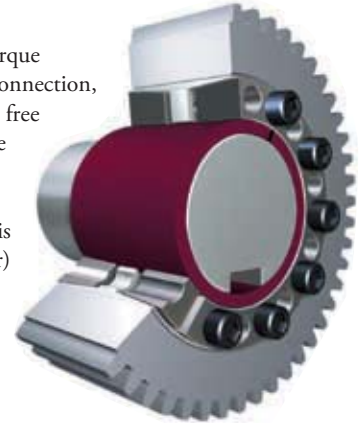

Notes:

- Sleeve ID =  $d_s - 0/+0.001$  (.025mm) where  $d_s$  = shaft diameter
- Sleeve OD =  $d + 0/-T_L$  for keyless bushing to be used
- Install dry (cleaned with non-petroleum-based solvent) at shaft/sleeve bore interface for coefficient of friction  $\mu = 0.15$
- Torque capacity at sleeve OD =  $M_t$  for keyless bushing to be used
- Torque capacity on shaft =  $M_t \times \frac{d_s}{d} \times 1.25$
- Sleeve to be manufactured with one lengthwise slit (after machining) and from material equal to or better than shaft material
- Sleeve can be installed over existing keyway; position slit approximately opposite keyway

## RADIAL LOADS

Radial loads are generated when force is applied perpendicular to the centerline of the shaft and are frequently associated with pin or axle connections (see illustration below). Fenner Drives Keyless Bushings are well suited to provide tight, backlash-free connections for this type of application, as explained below.

$$F_{rad} = \text{radial load capacity} = d \times L \times P_s$$

where:  $d$  = shaft diameter

$D$  = hub bore

$L$  = contact length

$P_h$  = hub pressure

$P_s$  = shaft contact pressure =  $P_h \times \frac{D}{d}$

Typical pressure distribution in backlash-free pin connections

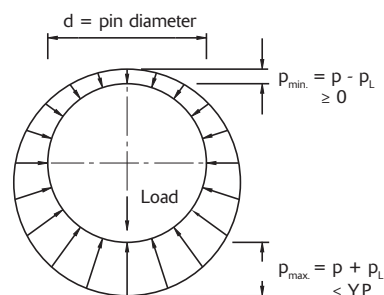

Explanations:

$p$  = contact pressure provided by keyless bushing

$p_L$  = contact pressure on projected contact area

$$= \frac{\text{load}}{d \times \text{contact length}}$$

Y.P. = yield point of pin material

## HUB SIZING

Fenner Drives Keyless Bushings transmit torque and other loads by means of mechanical interference generated by pressure exerted on both the shaft and mounted component hub. Therefore, consideration must be given to the amount of hub material (wall thickness) required to prevent permanent expansion (i.e., yielding). The following information is provided to assist you in determining the required hub diameter  $D_N$  for any keyless bushing application. You may also use the "Required Hub OD Calculation Tool" online at [www.fennerdrives.com](http://www.fennerdrives.com) for a quick and easy way to determine your needs.

From the stress equations presented below, the required hub diameter  $D_N$  is determined as follows:

$$D_N = D \sqrt{\frac{Y.P. + (P_h \times C)}{Y.P. - (P_h \times C)}}$$

where:  $D$  = hub bore diameter (from product specifications)

$P_h$  = contact pressure applied to hub bore (from product specifications)

Y.P. = tensile yield point of your hub material and

$C$  = Stress Reduction Factor which assumes the value of 1.0, 0.8 or 0.6 depending upon the relationship of your actual hub width  $H_w$  to the contact length  $L$  of the keyless bushing selected. Use the illustrations at right to determine  $C$  for your application.

**B-LOC® B109, B103, B106, B400, B800 & Trantorque®**

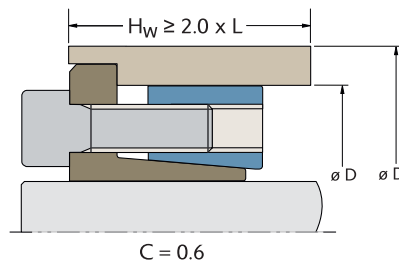
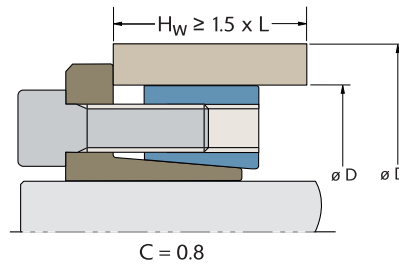
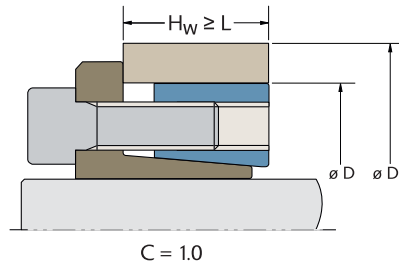

**B-LOC® B112, B113, & B115**

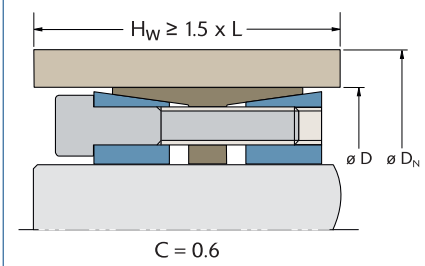
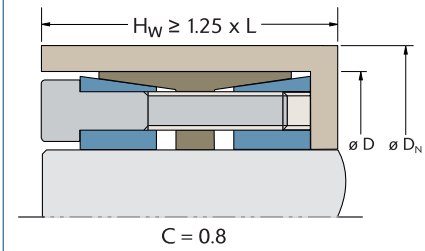
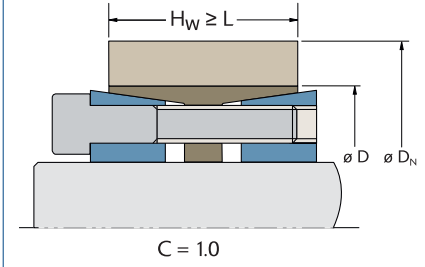

### THICK WALLED CYLINDER SUBJECTED TO INTERNAL PRESSURE

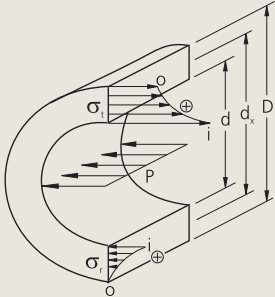

TANGENTIAL STRESSES " $\sigma_t$ "

$$\sigma_{tx} = P \frac{Q}{1-Q} \left[ 1 + \frac{D_o^2}{d_x^2} \right]$$

$$\sigma_{ti} = P \frac{1+Q}{1-Q}$$

$$\sigma_{to} = 2P \frac{Q}{1-Q}$$

RADIAL STRESSES " $\sigma_r$ "

$$\sigma_{rx} = P \frac{Q}{1-Q} \left[ 1 - \frac{D_o^2}{d_x^2} \right]$$

$$\sigma_{ri} = -P$$

$$\sigma_{ro} = 0$$

EXPANSION/  
CONTRACTION

$$\Delta d_i = P d_i \frac{(v+1) + (v-1)Q}{vE(1-Q)}$$

$$\Delta D_o = 2P \frac{D_o Q}{E(1-Q)}$$

### THICK WALLED CYLINDER SUBJECTED TO EXTERNAL PRESSURE

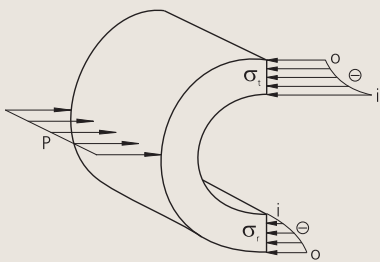

TANGENTIAL STRESSES " $\sigma_t$ "

$$\sigma_{tx} = -\frac{P}{1-Q} \left[ 1 + \frac{d_i^2}{d_x^2} \right]$$

$$\sigma_{ti} = -\frac{2P}{1-Q}$$

$$\sigma_{to} = -P \frac{1+Q}{1-Q}$$

RADIAL STRESSES " $\sigma_r$ "

$$\sigma_{rx} = -\frac{P}{1-Q} \left[ 1 - \frac{d_i^2}{d_x^2} \right]$$

$$\sigma_{ri} = 0$$

$$\sigma_{ro} = -P$$

EXPANSION/  
CONTRACTION

$$\Delta d_i = 2P \frac{d_i}{E(1-Q)}$$

$$\Delta D_o = P D_o \frac{(v-1) + (v+1)Q}{vE(1-Q)}$$

### COMBINED HUB STRESSES IN SHRINK DISC APPLICATIONS " $\sigma_v$ "

$$\sigma_v = \sqrt{\sigma_t^2 + \sigma_r^2 - (\sigma_t \sigma_r) + \tau^2}$$

KEY  $i$  = inside of hub  
 $o$  = outside of hub  
 $v$  = poisson's ratio (.3003 for steel)  
 $E$  = modulus of elasticity ( $30 \times 10^6$  psi for steel)

$P$  = pressure  
 $\tau$  = torsional hub stress  
 $Q = \left(\frac{d}{D}\right)^2$





Locking screws transfer to integrated push-off holes for disassembly.

Metric socket head locking screws  
DIN 912 grade 12.9  
(See  $M_A$  for install torque).

Screw head height = screw diameter (mm)

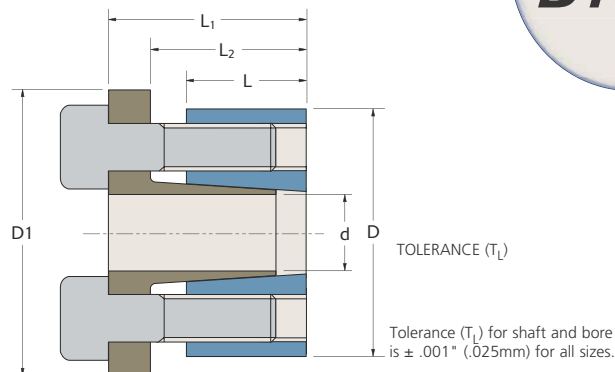

## B109 – Inch

Part Number	d (inch)	D (inch)	D <sub>1</sub> (inch)	L (inch)	L <sub>1</sub> (inch)	L <sub>2</sub> (inch)	Locking Screws		M <sub>a</sub>	M <sub>t</sub>	Th	Ph	DN*	Shipping Weight (lb)
							Qty	Size	Install Torque (in lb)	Maximum Transmitted		Hub Pressure (psi)	Minimum Hub Diameter (inch)	
										Torque (in lb)	Thrust (lbs)			
T902004	1/4	13/16	15/16	0.394	0.650	0.516	3	M4 x 12	36.0	167	1336	11073	1.045	0.1
T902005	5/16	7/8	1	0.394	0.650	0.516	3	M4 x 12	42.5	246	1572	12096	1.153	0.1
T902006	3/8	15/16	1 1/16	0.394	0.650	0.516	3	M4 x 12	42.5	295	1572	11290	1.211	0.1
B902008	1/2	1 1/16	1 3/16	0.394	0.650	0.516	4	M4 x 12	42.5	524	2096	13282	1.440	0.1
T902010	5/8	1 3/16	1 5/16	0.472	0.807	0.594	6	M4 x 14	42.5	983	3144	14880	1.674	0.2
B902012	3/4	1 5/16	1 7/16	0.472	0.807	0.594	6	M4 x 14	42.5	1179	3144	13463	1.787	0.2
T902014	7/8	1 9/16	1 3/4	0.591	0.984	0.754	6	M5 x 18	87.0	2264	5174	14863	2.202	0.4
B902100	1	1 11/16	1 7/8	0.591	0.984	0.754	8	M5 x 18	87.0	3449	6899	18349	2.602	0.4
T902102	1 1/8	1 7/8	2	0.669	1.102	0.829	9	M5 x 18	87.0	4366	7761	16412	2.748	0.6
T902103	1 3/16	1 15/16	2 1/16	0.669	1.102	0.829	10	M5 x 18	87.0	5120	8623	17647	2.932	0.6
B902104	1 1/4	2	2 1/8	0.669	1.102	0.829	10	M5 x 18	87.0	5390	8623	17096	2.984	0.6
B902106	1 3/8	2 1/8	2 1/4	0.669	1.102	0.829	10	M5 x 18	87.0	5929	8623	16090	3.089	0.6

## B109 – Metric

Part Number	d (mm)	D (mm)	D <sub>1</sub> (mm)	L (mm)	L <sub>1</sub> (mm)	L <sub>2</sub> (mm)	Locking Screws		M <sub>a</sub>	M <sub>t</sub>	Th	Ph	DN*	Shipping Weight (kg)
							Qty	Size	Install Torque (Nm)	Maximum Transmitted		Hub Pressure (N/mm <sup>2</sup> )	Minimum Hub Diameter (mm)	
										Torque (Nm)	Thrust (N)			
T901006	6	20.64	23.81	10	16.5	13.1	3	M4 x 12	4.3	19	6192	80	26.8	0.05
T901008	8	22.23	25.40	10	16.5	13.1	3	M4 x 12	5	29	7285	87	29.6	0.05
B901010	10	23.81	27.00	10	16.5	13.1	3	M4 x 12	5	36	7285	81	31.1	0.05
T901011	11	26.99	30.16	10	16.5	13.1	4	M4 x 12	5	53	9713	95	37.1	0.05
T901012	12	26.99	30.16	10	16.5	13.1	4	M4 x 12	5	58	9713	95	37.1	0.05
T901014	14	30.16	33.34	12	20.5	15.1	6	M4 x 14	5	102	14569	107	43.2	0.05
T901015	15	30.16	33.34	12	20.5	15.1	6	M4 x 14	5	109	14569	107	43.2	0.09
T901016	16	30.16	33.34	12	20.5	15.1	6	M4 x 14	5	117	14569	107	43.2	0.09
T901019	19	33.34	36.51	12	20.5	15.1	6	M4 x 14	5	138	14569	97	46.0	0.09
T901020	20	39.69	44.45	15	25	19.2	6	M5 x 18	10	234	23414	104	56.3	0.18
T901022	22	39.69	44.45	15	25	19.2	6	M5 x 18	10	258	23414	104	56.3	0.18
T901024	24	42.86	47.62	15	25	19.2	8	M5 x 18	10	375	31219	129	66.7	0.18
T901025	25	42.86	47.62	15	25	19.2	8	M5 x 18	10	390	31219	129	66.7	0.18
T901028	28	47.62	50.80	17	28	21.06	9	M5 x 18	10	492	35121	115	70.3	0.27
T901030	30	49.21	52.39	17	28	21.06	10	M5 x 18	10	585	39024	124	75.1	0.27
T901032	32	50.80	53.97	17	28	21.06	10	M5 x 18	10	624	39024	120	76.4	0.27
T901035	35	53.98	57.15	17	28	21.06	10	M5 x 18	10	683	39024	113	79.0	0.27

\*Required hub OD for 1045 h.r. steel hub assuming 45 ksi Yield Point and Stress Reduction Factor C=1 (see page 16 for details)

# B-LOC B103



Locking screws transfer to integrated push-off holes for disassembly.

Metric socket head locking screws  
DIN 912 grade 12.9  
(See  $M_A$  for install torque).

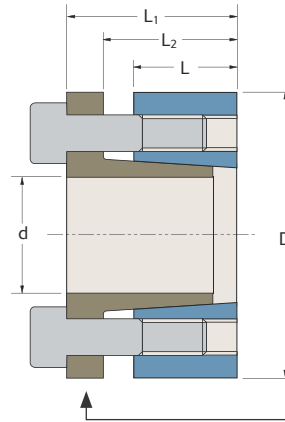

TOLERANCE ( $T_L$ )

Bore diameter machined to  $D -0/+T_L$   
 $T_L = .002"$  for bores up to 4.724"  
 $.003"$  for bores up to 12.008"  
 $.004"$  for bores over 12.008"

$d =$  Shaft diameter machined to  $d +0/-T_L$

Note: Flange of Series B103 locking assemblies should be located inside of hub bore.

Screw head height = screw diameter (mm)

## B103 – Inch

Part Number	d (inch)	D (inch)	L (inch)	L <sub>1</sub> (inch)	L <sub>2</sub> (inch)	Locking Screws		M <sub>a</sub> Install Torque (ft lb)	M <sub>t</sub> Maximum Torque (ft lb)	T <sub>h</sub> Thrust (lbs)	P <sub>h</sub> Hub Pressure (psi)	D <sub>N</sub> * Minimum Hub Diameter (inch)	Shipping Weight (lb)
						Qty	Size						
B302012	3/4	1.850	0.669	1.122	0.886	5	M6 x 20	10	247	7918	16959	2.751	0.6
T302014	7/8	1.850	0.669	1.122	0.886	5	M6 x 20	10	289	7918	16959	2.751	0.6
B302100	1	1.969	0.669	1.122	0.886	6	M6 x 20	10	396	9502	19130	3.099	0.7
B302102	1 1/8	2.165	0.669	1.122	0.886	6	M6 x 20	10	445	9502	17391	3.255	0.8
B302103	1 3/16	2.165	0.669	1.122	0.886	6	M6 x 20	10	470	9502	17391	3.255	0.7
B302104	1 1/4	2.362	0.669	1.122	0.886	8	M6 x 20	10	660	12669	21256	3.946	0.9
B302106	1 3/8	2.362	0.669	1.122	0.886	8	M6 x 20	10	726	12669	21256	3.946	0.8
B302107	1 7/16	2.559	0.669	1.122	0.886	8	M6 x 20	10	759	12669	19621	4.083	1.0
B302108	1 1/2	2.559	0.669	1.122	0.886	8	M6 x 20	10	792	12669	19621	4.083	1.0
B302110	1 5/8	2.953	0.787	1.358	1.043	7	M8 x 25	25	1439	21250	24245	5.393	1.7
T302111	1 11/16	2.953	0.787	1.358	1.043	7	M8 x 25	25	1494	21250	24245	5.393	1.6
B302112	1 3/4	2.953	0.787	1.358	1.043	7	M8 x 25	25	1550	21250	24245	5.393	1.6
T302114	1 7/8	3.150	0.787	1.358	1.043	7	M8 x 25	25	1660	21250	22729	5.493	1.8
B302115	1 15/16	3.150	0.787	1.358	1.043	7	M8 x 25	25	1716	21250	22729	5.493	1.7
B302200	2	3.150	0.787	1.358	1.043	7	M8 x 25	25	1771	21250	22729	5.493	1.6
T302202	2 1/8	3.346	0.787	1.358	1.043	8	M8 x 25	25	2150	24286	24448	6.152	1.9
B302203	2 3/16	3.346	0.787	1.358	1.043	8	M8 x 25	25	2214	24286	24448	6.152	1.8
B302204	2 1/4	3.543	0.787	1.358	1.043	8	M8 x 25	25	2277	24286	23090	6.246	2.1
T302206	2 3/8	3.543	0.787	1.358	1.043	8	M8 x 25	25	2403	24286	23090	6.246	1.9
B302207	2 7/16	3.740	0.787	1.358	1.043	9	M8 x 25	25	2775	27322	24609	6.910	2.2
B302208	2 1/2	3.740	0.787	1.358	1.043	9	M8 x 25	25	2846	27322	24609	6.910	2.2
T302209	2 9/16	3.740	0.787	1.358	1.043	9	M8 x 25	25	2917	27322	24609	6.910	2.1
T302211	2 11/16	4.331	0.945	1.594	1.201	8	M10 x 30	50	4411	39387	25532	8.243	3.8
T302212	2 3/4	4.331	0.945	1.594	1.201	8	M10 x 30	50	4513	39387	25532	8.243	3.7
T302214	2 7/8	4.528	0.945	1.594	1.201	8	M10 x 30	50	4718	39387	24422	8.316	4.0
B302215	2 15/16	4.528	0.945	1.594	1.201	8	M10 x 30	50	4821	39387	24422	8.316	3.9
B302300	3	4.724	0.945	1.594	1.201	8	M10 x 30	50	4923	39387	23404	8.408	4.4
T302304	3 1/4	4.921	0.945	1.594	1.201	9	M10 x 30	50	6000	44311	25277	9.290	4.5
T302306	3 3/8	4.921	0.945	1.594	1.201	9	M10 x 30	50	6231	44311	25277	9.290	4.3
B302307	3 7/16	5.118	0.945	1.594	1.201	9	M10 x 30	50	6347	44311	24305	9.366	4.8
T302308	3 1/2	5.118	0.945	1.594	1.201	9	M10 x 30	50	6462	44311	24305	9.366	4.6
T302312	3 3/4	5.315	0.945	1.594	1.201	10	M10 x 30	50	7693	49234	26005	10.276	4.7
T302315	3 15/16	5.709	1.024	1.772	1.299	8	M12 x 35	90	9944	60608	27512	11.624	6
T302400	4	5.709	1.024	1.772	1.299	8	M12 x 35	90	10101	60608	27512	11.624	6
T302407	4 7/16	6.102	1.024	1.772	1.299	8	M12 x 35	90	11206	60608	25737	11.694	6
T302412	4 3/4	6.496	1.024	1.772	1.299	9	M12 x 35	90	13495	68184	27200	13.083	7
T302415	4 15/16	7.087	1.339	2.165	1.614	9	M14 x 40	135	18113	88043	24620	13.098	11
B302500	5	7.087	1.339	2.165	1.614	9	M14 x 40	135	18342	88043	24620	13.098	11
T302507	5 7/16	7.480	1.339	2.165	1.614	9	M14 x 40	135	19947	88043	23324	13.280	12
T302515	5 15/16	7.874	1.339	2.165	1.614	10	M14 x 40	135	24202	97825	24620	14.553	12
T302607	6 7/16	8.858	1.732	2.559	2.008	12	M14 x 40	135	31488	117391	20292	14.400	20
T302615	6 15/16	9.252	1.732	2.559	2.008	12	M14 x 40	135	33933	117391	19429	14.686	20
B302700	7	9.252	1.732	2.559	2.008	12	M14 x 40	135	34239	117391	19429	14.686	20
T302707	7 7/16	9.843	1.732	2.559	2.008	15	M14 x 40	135	45474	146738	22829	17.216	22
T302715	7 15/16	10.236	1.732	2.559	2.008	15	M14 x 40	135	48531	146738	21951	17.446	23
T302800	8	10.236	1.732	2.559	2.008	15	M14 x 40	135	48913	146738	21951	17.446	21

\*Required hub OD for 1045 h.r. steel hub assuming 45 ksi Yield Point and Stress Reduction Factor C=1 (see page 16 for details)

TOLERANCE (T<sub>L</sub>)

Bore diameter machined to D -0/+T<sub>L</sub>  
 T<sub>L</sub> = .05mm for bores up to 120mm  
 .08mm for bores up to 305mm  
 .10mm for bores over 305mm

d = Shaft diameter machined to d +0/-T<sub>L</sub>

### B103 – Metric

Part Number	d (mm)	D (mm)	L (mm)	L <sub>1</sub> (mm)	L <sub>2</sub> (mm)	Locking Screws		M <sub>a</sub>	M <sub>t</sub>	T <sub>h</sub>	P <sub>h</sub>	D <sub>N</sub> *	Shipping Weight (kg)
						Qty	Size						
								Install Torque (Nm)	Torque (Nm)	Thrust (N)	Hub Pressure (N/mm <sup>2</sup> )		
T301015	15	32	14	21.5	18	4	M4 x 12	5	115	15390	91	43.3	0.1
T301018	18	47	17	28.5	22.5	5	M6 x 20	14	327	36371	121	70.9	0.3
T301019	19	47	17	28.5	22.5	5	M6 x 20	14	346	36371	121	70.9	0.3
T301020	20	47	17	28.5	22.5	5	M6 x 20	14	364	36371	121	70.9	0.3
T301022	22	47	17	28.5	22.5	5	M6 x 20	14	400	36371	121	70.9	0.2
T301024	24	50	17	28.5	22.5	6	M6 x 20	14	524	43645	136	80.1	0.3
B301025	25	50	17	28.5	22.5	6	M6 x 20	14	546	43645	136	80.1	0.3
T301028	28	55	17	28.5	22.5	6	M6 x 20	14	611	43645	124	83.9	0.3
B301030	30	55	17	28.5	22.5	6	M6 x 20	14	655	43645	124	83.9	0.3
T301032	32	60	17	28.5	22.5	8	M6 x 20	14	931	58193	151	102.3	0.4
B301035	35	60	17	28.5	22.5	8	M6 x 20	14	1018	58193	151	102.3	0.3
T301038	38	65	17	28.5	22.5	8	M6 x 20	14	1106	58193	140	105.6	0.4
B301040	40	65	17	28.5	22.5	8	M6 x 20	14	1164	58193	140	105.6	0.4
T301042	42	75	20	34.5	26.5	7	M8 x 25	34	1991	94822	168	137.3	0.7
B301045	45	75	20	34.5	26.5	7	M8 x 25	34	2133	94822	168	137.3	0.6
B301050	50	80	20	34.5	26.5	7	M8 x 25	34	2371	94822	157	139.8	0.7
T301055	55	85	20	34.5	26.5	8	M8 x 25	34	2980	108368	169	156.6	0.8
B301060	60	90	20	34.5	26.5	8	M8 x 25	34	3251	108368	160	159.0	0.8
T301065	65	95	20	34.5	26.5	9	M8 x 25	34	3962	121914	170	176.0	0.9
B301070	70	110	24	40.5	30.5	8	M10 x 30	68	6151	175750	177	209.9	1.6
T301075	75	115	24	40.5	30.5	8	M10 x 30	68	6591	175750	169	211.7	1.6
T301080	80	120	24	40.5	30.5	8	M10 x 30	68	7030	175750	162	214.0	1.7
B301085	85	125	24	40.5	30.5	9	M10 x 30	68	8403	197719	175	236.6	1.8
T301090	90	130	24	40.5	30.5	9	M10 x 30	68	8897	197719	168	238.5	1.9
T301095	95	135	24	40.5	30.5	10	M10 x 30	68	10435	219688	180	261.7	2
B301100	100	145	26	45	33	8	M12 x 35	122	13478	269557	190	295.2	3
T301110	110	155	26	45	33	8	M12 x 35	122	14826	269557	177	297.0	3
B301120	120	165	26	45	33	9	M12 x 35	122	18195	303251	188	332.3	3
T301130	130	180	34	55	41	9	M14 x 40	183	25452	391574	170	332.6	5
T301140	140	190	34	55	41	9	M14 x 40	183	27410	391574	161	337.3	5
T301150	150	200	34	55	41	10	M14 x 40	183	32631	435082	170	369.6	5
T301160	160	210	34	55	41	11	M14 x 40	183	38287	478591	178	403.1	6
T301170	170	225	44	65	51	12	M14 x 40	183	44378	522099	140	365.7	8
T301180	180	235	44	65	51	12	M14 x 40	183	46989	522099	134	373.0	8
T301190	190	250	44	65	51	15	M14 x 40	183	61999	652624	157	437.2	9
T301200	200	260	44	65	51	15	M14 x 40	183	65262	652624	151	443.1	10
T301220	220	285	50	73	57	12	M16 x 45	297	82145	746770	139	461.6	13
T301240	240	305	50	73	57	15	M16 x 45	297	112016	933463	162	545.2	14
T301260	260	325	50	73	57	18	M16 x 45	297	145620	1120155	183	639.4	15
T301280	280	355	60	85	67	16	M18 x 50	393	163726	1169473	146	590.8	23
T301300	300	375	60	85	67	18	M18 x 50	393	197349	1315657	155	649.4	24
T301320	320	405	74	102	82	18	M20 x 50	569	274346	1714665	152	691.5	34
T301340	340	425	74	102	82	21	M20 x 50	569	340075	2000443	169	781.8	36
T301360	360	455	86	116	94	18	M22 x 60	759	377769	2098718	142	746.8	49
T301380	380	475	86	116	94	21	M22 x 60	759	465216	2448505	159	836.6	52
T301400	400	495	86	116	94	21	M22 x 60	759	489701	2448505	153	848.0	55

\*Required hub OD for 1045 h.r. steel hub assuming 45 ksi Yield Point and Stress Reduction Factor C=1 (see page 16 for details)

# B-LOC B106



Locking screws transfer to integrated push-off holes for disassembly.

Metric socket head locking screws  
DIN 912 grade 12.9  
(See M<sub>a</sub> for install torque).

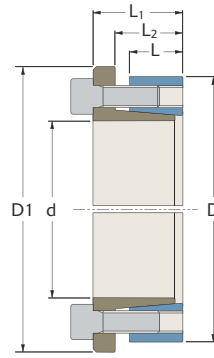

TOLERANCE (T<sub>L</sub>)

Bore dia. machined to D -0/+T<sub>L</sub>  
T<sub>L</sub> = .002" for bores up to 4.724"  
.003" for bores up to 12.008"  
.004" for bores over 12.008"

d = Shaft diameter machined to d +0/-T<sub>L</sub>

Screw head height = screw diameter (mm)

## B106 – Inch

Part Number	d (inch)	D (inch)	D <sub>1</sub> (inch)	L (inch)	L <sub>1</sub> (inch)	L <sub>2</sub> (inch)	Locking Screws		M <sub>a</sub>	M <sub>t</sub>	T <sub>h</sub>	P <sub>h</sub>	D <sub>N</sub> *	Shipping Weight (lb)
							Qty	Size						
							Install Torque (ft lb)	Maximum Transmitted Torque (ft lb)	Thrust (lbs)	Hub Pressure (psi)				
T602010	5/8	1.260	1.457	0.551	0.846	0.709	4	M4 x 12	3.5	55	2096	8007	1.508	0.6
B602012	3/4	1.850	2.047	0.669	1.122	0.886	5	M6 x 20	12	187	5997	12845	2.482	0.6
B602014	7/8	1.850	2.047	0.669	1.122	0.886	5	M6 x 20	12	219	5997	12845	2.482	0.7
T602015	15/16	1.969	2.224	0.669	1.122	0.886	5	M6 x 20	12	234	5997	12071	2.592	0.6
B602100	1	1.969	2.224	0.669	1.122	0.886	6	M6 x 20	12	300	7196	14489	2.749	0.7
B602102	1 1/8	2.165	2.421	0.669	1.122	0.886	6	M6 x 20	12	337	7196	13172	2.927	0.8
B602103	1 3/16	2.165	2.421	0.669	1.122	0.886	6	M6 x 20	12	356	7196	13172	2.927	0.7
B602104	1 1/4	2.362	2.618	0.669	1.122	0.886	8	M6 x 20	12	500	9595	16099	3.435	0.9
B602106	1 3/8	2.362	2.618	0.669	1.122	0.886	8	M6 x 20	12	550	9595	16099	3.435	0.8
B602107	1 7/16	2.559	2.815	0.669	1.122	0.886	8	M6 x 20	12	575	9595	14860	3.606	1.0
B602108	1 1/2	2.559	2.815	0.669	1.122	0.886	8	M6 x 20	12	600	9595	14860	3.606	1.0
B602110	1 5/8	2.953	3.287	0.787	1.358	1.043	7	M8 x 25	30	1090	16094	18362	4.554	1.7
B602111	1 11/16	2.953	3.287	0.787	1.358	1.043	7	M8 x 25	30	1132	16094	18362	4.554	1.6
B602112	1 3/4	2.953	3.287	0.787	1.358	1.043	7	M8 x 25	30	1174	16094	18362	4.554	1.6
B602114	1 7/8	3.150	3.484	0.787	1.358	1.043	7	M8 x 25	30	1257	16094	17214	4.713	1.8
B602115	1 15/16	3.150	3.484	0.787	1.358	1.043	7	M8 x 25	30	1299	16094	17214	4.713	1.7
B602200	2	3.150	3.484	0.787	1.358	1.043	7	M8 x 25	30	1341	16094	17214	4.713	1.6
T602202	2 1/8	3.346	3.681	0.787	1.358	1.043	8	M8 x 25	30	1629	18393	18516	5.182	1.9
B602203	2 3/16	3.346	3.681	0.787	1.358	1.043	8	M8 x 25	30	1676	18393	18516	5.182	1.8
B602204	2 1/4	3.543	3.898	0.787	1.358	1.043	8	M8 x 25	30	1724	18393	17487	5.340	2.1
B602206	2 3/8	3.543	3.898	0.787	1.358	1.043	8	M8 x 25	30	1820	18393	17487	5.340	1.9
B602207	2 7/16	3.740	4.016	0.787	1.358	1.043	9	M8 x 25	30	2102	20693	18638	5.811	2.2
B602208	2 1/2	3.740	4.016	0.787	1.358	1.043	9	M8 x 25	30	2155	20693	18638	5.811	2.2
T602209	2 9/16	3.740	4.016	0.787	1.358	1.043	9	M8 x 25	30	2209	20693	18638	5.811	2.1
T602211	2 11/16	4.331	4.685	0.945	1.594	1.201	8	M10 x 30	60	3340	29831	19337	6.857	3.8
B602212	2 3/4	4.331	4.685	0.945	1.594	1.201	8	M10 x 30	60	3418	29831	19337	6.857	3.7
B602214	2 7/8	4.528	4.882	0.945	1.594	1.201	8	M10 x 30	60	3573	29831	18496	7.008	4.0
B602215	2 15/16	4.528	4.882	0.945	1.594	1.201	8	M10 x 30	60	3651	29831	18496	7.008	3.9
B602300	3	4.724	5.079	0.945	1.594	1.201	8	M10 x 30	60	3729	29831	17726	7.165	4.4
B602304	3 1/4	4.921	5.276	0.945	1.594	1.201	9	M10 x 30	60	4545	33559	19144	7.751	4.5
T602306	3 3/8	4.921	5.276	0.945	1.594	1.201	9	M10 x 30	60	4719	33559	19144	7.751	4.3
B602307	3 7/16	5.118	5.472	0.945	1.594	1.201	9	M10 x 30	60	4807	33559	18408	7.903	4.8
B602308	3 1/2	5.118	5.472	0.945	1.594	1.201	9	M10 x 30	60	4894	33559	18408	7.903	4.6
T602312	3 3/4	5.315	5.669	0.945	1.594	1.201	10	M10 x 30	60	5826	37288	19695	8.498	4.7
T602315	3 15/16	5.709	6.063	1.024	1.772	1.299	8	M12 x 35	105	7322	44627	20258	9.271	6
B602400	4	5.709	6.063	1.024	1.772	1.299	8	M12 x 35	105	7438	44627	20258	9.271	6
B602407	4 7/16	6.102	6.457	1.024	1.772	1.299	8	M12 x 35	105	8251	44627	18951	9.561	6
T602412	4 3/4	6.496	6.850	1.024	1.772	1.299	9	M12 x 35	105	9936	50205	20028	10.483	7
B602415	4 15/16	7.087	7.441	1.339	2.165	1.614	9	M14 x 40	166	14057	68327	19106	11.150	11
T602500	5	7.087	7.441	1.339	2.165	1.614	9	M14 x 40	166	14235	68327	19106	11.150	11
B602507	5 7/16	7.480	7.835	1.339	2.165	1.614	9	M14 x 40	166	15480	68327	18101	11.457	12
B602515	5 15/16	7.874	8.228	1.339	2.165	1.614	10	M14 x 40	166	18782	75918	19106	12.389	12
B602607	6 7/16	8.858	9.213	1.732	2.559	2.008	12	M14 x 40	166	24436	91102	15748	12.766	20
T602615	6 15/16	9.252	9.606	1.732	2.559	2.008	12	M14 x 40	166	26334	91102	15078	13.110	20
B602700	7	9.252	9.606	1.732	2.559	2.008	12	M14 x 40	166	26571	91102	15078	13.110	20
B602707	7 7/16	9.843	10.197	1.732	2.559	2.008	15	M14 x 40	166	35290	113878	17717	14.923	22
T602715	7 15/16	10.236	10.591	1.732	2.559	2.008	15	M14 x 40	166	37663	113878	17035	15.246	23
T602800	8	10.236	10.591	1.732	2.559	2.008	15	M14 x 40	166	37959	113878	17035	15.246	21

\*Required hub OD for 1045 h.r. steel hub assuming 45 ksi Yield Point and Stress Reduction Factor C=1 (see page 16 for details)



### TOLERANCE (T<sub>L</sub>)

Bore diameter machined to D -0/+T<sub>L</sub>  
 T<sub>L</sub> = .05mm for bores up to 120mm  
 .08mm for bores up to 305mm  
 .10mm for bores over 305mm

d = Shaft diameter machined to d +0/-T<sub>L</sub>

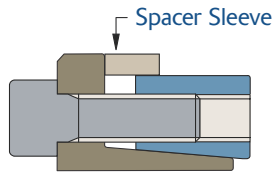

Note: Series B106 also available with optional integrated spacer sleeve (ideal for very narrow drive elements). Spacers are 0.275" wide for B106 sizes with D=2.559" (65mm) and smaller, and 0.315" wide for all others.

### B106 – Metric

Part Number	d (mm)	D (mm)	D <sub>1</sub> (mm)	L (mm)	L <sub>1</sub> (mm)	L <sub>2</sub> (mm)	Locking Screws		M <sub>a</sub>	M <sub>t</sub>	T <sub>h</sub>	P <sub>h</sub>	D <sub>N</sub> *	Shipping Weight (kg)
							Qty	Size						
							Install Torque (Nm)	Maximum Transmitted Torque (Nm)	Hub Pressure (N/mm <sup>2</sup> )	Minimum Hub Diameter (mm)				
T601014	14	28	32	14	20.5	17	4	M4 x 12	5	68	9713	66	34.7	0.1
T601015	15	28	32	14	20.5	17	4	M4 x 12	5	73	9713	66	34.7	0.1
T601018	18	47	52	17	28.5	22.5	5	M6 x 20	16	236	26234	87	62.7	0.3
T601019	19	47	52	17	28.5	22.5	5	M6 x 20	16	249	26234	87	62.7	0.3
T601020	20	47	52	17	28.5	22.5	5	M6 x 20	16	262	26234	87	62.7	0.3
B601022	22	47	52	17	28.5	22.5	5	M6 x 20	16	289	26234	87	62.7	0.3
T601024	24	50	56.5	17	28.5	22.5	6	M6 x 20	16	378	31481	98	69.4	0.3
B601025	25	50	56.5	17	28.5	22.5	6	M6 x 20	16	394	31481	98	69.4	0.3
B601028	28	55	61.5	17	28.5	22.5	6	M6 x 20	16	441	31481	89	74.0	0.4
B601030	30	55	61.5	17	28.5	22.5	6	M6 x 20	16	472	31481	89	74.0	0.3
T601032	32	60	66.5	17	28.5	22.5	8	M6 x 20	16	672	41975	109	86.6	0.4
B601035	35	60	66.5	17	28.5	22.5	8	M6 x 20	16	735	41975	109	86.6	0.4
T601038	38	65	71.5	17	28.5	22.5	8	M6 x 20	16	798	41975	101	91.0	0.5
B601040	40	65	71.5	17	28.5	22.5	8	M6 x 20	16	839	41975	101	91.0	0.4
T601042	42	75	83.5	20	34.5	26.5	7	M8 x 25	41	1515	72167	128	116.1	0.8
B601045	45	75	83.5	20	34.5	26.5	7	M8 x 25	41	1624	72167	128	116.1	0.7
T601048	48	80	88.5	20	34.5	26.5	7	M8 x 25	41	1732	72167	120	120.1	0.8
B601050	50	80	88.5	20	34.5	26.5	7	M8 x 25	41	1804	72167	120	120.1	0.8
B601055	55	85	93.5	20	34.5	26.5	8	M8 x 25	41	2268	82476	129	132.2	0.8
B601060	60	90	98	20	34.5	26.5	8	M8 x 25	41	2474	82476	122	136.1	0.9
T601063	63	95	102	20	34.5	26.5	9	M8 x 25	41	2923	92786	130	148.2	0.9
T601065	65	95	102	20	34.5	26.5	9	M8 x 25	41	3016	92786	130	148.2	0.9
T601070	70	110	119	24	40.5	30.5	8	M10 x 30	81	4624	132127	133	173.8	1.7
B601075	75	115	124	24	40.5	30.5	8	M10 x 30	81	4955	132127	127	177.6	1.8
B601080	80	120	129	24	40.5	30.5	8	M10 x 30	81	5285	132127	122	181.6	1.9
T601085	85	125	134	24	40.5	30.5	9	M10 x 30	81	6317	148643	131	196.4	2
B601090	90	130	139	24	40.5	30.5	9	M10 x 30	81	6689	148643	126	200.3	2
T601095	95	135	144	24	40.5	30.5	10	M10 x 30	81	7845	165159	135	215.4	2
B601100	100	145	154	26	45	33	8	M12 x 35	142	9901	198016	139	235.2	3
B601110	110	155	164	26	45	33	8	M12 x 35	142	10891	198016	130	242.6	3
B601120	120	165	174	26	45	33	9	M12 x 35	142	13366	222768	138	265.9	3
T601130	130	180	189	34	55	41	9	M14 x 40	225	19751	303855	132	283.2	5
B601140	140	190	199	34	55	41	9	M14 x 40	225	21270	303855	125	291.0	5
T601150	150	200	209	34	55	41	10	M14 x 40	225	25321	337617	132	314.6	6
B601160	160	210	219	34	55	41	11	M14 x 40	225	29710	371379	138	338.7	6
B601170	170	225	234	44	65	51	12	M14 x 40	225	34437	405140	109	324.2	8
B601180	180	235	244	44	65	51	12	M14 x 40	225	36463	405140	104	333.0	9
T601190	190	250	259	44	65	51	15	M14 x 40	225	48110	506425	122	379.0	10
B601200	200	260	269	44	65	51	15	M14 x 40	225	50643	506425	117	387.2	10
T601220	220	285	294	50	73	57	12	M16 x 45	348	60747	552244	103	402.1	14
T601240	240	305	314	50	73	57	15	M16 x 45	348	82837	690305	120	458.8	15
T601260	260	325	334	50	73	57	18	M16 x 45	348	107688	828366	135	518.5	16
T601280	280	355	364	60	85	67	16	M18 x 50	475	124894	892098	111	516.4	23
T601300	300	375	384	60	85	67	18	M18 x 50	475	150542	1003610	118	560.3	25
T601320	320	405	414	74	102	82	18	M20 x 50	678	206318	1289490	114	595.7	35
T601340	340	425	434	74	102	82	21	M20 x 50	678	255749	1504405	127	656.2	37
T601360	360	455	464	86	116	94	18	M22 x 60	915	287427	1596815	108	654.9	51
T601380	380	475	484	86	116	94	21	M22 x 60	915	353961	1862951	121	716.9	53
T601400	400	495	504	86	116	94	21	M22 x 60	915	372590	1862951	116	733.5	57

\*Required hub OD for 1045 h.r. steel hub assuming 45 ksi Yield Point and Stress Reduction Factor C=1 (see page 16 for details)

# B-LOC B400

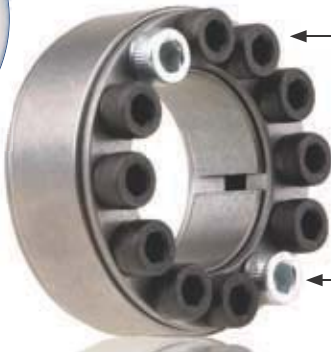

Metric socket head locking screws DIN 912 grade 12.9 (See  $M_a$  for install torque).

(2) or (3) equally spaced zinc plated screws provided solely to indicate position of partial pull out threads size  $d_B$ .

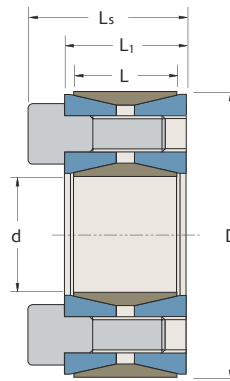

### TOLERANCE ( $T_L$ )

Bore diameter machined to  $D -0/+T_L$   
 $T_L =$  .002" for bores up to 1.969"  
 .003" for bores up to 4.724"  
 .004" for bores up to 9.252"  
 .005" for bores up to 14.764"  
 .006" for bores over 14.764"

$d =$  Shaft diameter machined to  $d +0/-T_L$

## B400 – Inch

Screw head height = screw diameter (mm)

Part Number	d (inch)	D (inch)	L (inch)	$L_1$ (inch)	$L_s$ (inch)	Locking Screws		$M_a$	$d_B$	Maximum Transmitted		$P_h$	$D_N^*$	Shipping Weight (lb)			
						Qty	Size			Install Torque (ft lb)	Torque (ft lb)				Thrust (lbs)	Hub Pressure (psi)	Minimum Hub Diameter (inch)
B402012	3/4	1.850	0.669	0.787	1.024	8	M6 x 18	11	M8	234	7501	16067	2.688	0.5			
B402014	7/8	1.850	0.669	0.787	1.024	8	M6 x 18	11	M8	273	7501	16067	2.688	0.5			
B402100	1	1.969	0.669	0.787	1.024	9	M6 x 18	11	M8	352	8439	16991	2.929	0.5			
B402102	1 1/8	2.165	0.669	0.787	1.024	10	M6 x 18	11	M8	440	9377	17162	3.236	0.6			
T402103	1 3/16	2.159	0.669	0.787	1.024	10	M6 x 18	11	M8	464	9377	17212	3.231	0.6			
B402104	1 1/4	2.362	0.669	0.787	1.024	12	M6 x 18	11	M8	586	11252	18880	3.694	0.7			
T402106	1 3/8	2.365	0.669	0.787	1.024	12	M6 x 18	11	M8	645	11252	18856	3.696	0.6			
B402107	1 7/16	2.559	0.669	0.787	1.024	14	M6 x 18	11	M8	786	13127	20331	4.164	0.8			
B402108	1 1/2	2.559	0.669	0.787	1.024	14	M6 x 18	11	M8	820	13127	20331	4.164	0.7			
B402110	1 5/8	2.953	0.787	0.945	1.260	12	M8 x 22	26	M10	1381	20393	23267	5.233	1.3			
B402111	1 11/16	2.953	0.787	0.945	1.260	12	M8 x 22	26	M10	1434	20393	23267	5.233	1.2			
B402112	1 3/4	2.953	0.787	0.945	1.260	12	M8 x 22	26	M10	1487	20393	23267	5.233	1.2			
B402114	1 7/8	3.150	0.787	0.945	1.260	12	M8 x 22	26	M10	1593	20393	21812	5.346	1.3			
B402115	1 15/16	3.150	0.787	0.945	1.260	12	M8 x 22	26	M10	1646	20393	21812	5.346	1.3			
B402200	2	3.346	0.787	0.945	1.260	14	M8 x 22	26	M10	1983	23792	23951	6.057	1.5			
B402202	2 1/8	3.346	0.787	0.945	1.260	14	M8 x 22	26	M10	2107	23792	23951	6.057	1.4			
B402203	2 3/16	3.543	0.787	0.945	1.260	14	M8 x 22	26	M10	2169	23792	22622	6.159	1.6			
B402204	2 1/4	3.543	0.787	0.945	1.260	14	M8 x 22	26	M10	2231	23792	22620	6.159	1.5			
T402206	2 3/8	3.531	0.787	0.945	1.260	14	M8 x 22	26	M10	2354	23792	22699	6.152	1.4			
B402207	2 7/16	3.740	0.787	0.945	1.260	16	M8 x 22	26	M10	2762	27191	24491	6.885	1.6			
B402208	2 1/2	3.740	0.787	0.945	1.260	16	M8 x 22	26	M10	2832	27191	24491	6.885	1.6			
T402209	2 9/16	3.737	0.787	0.945	1.260	16	M8 x 22	26	M10	2903	27191	24512	6.883	1.5			
B402210	2 5/8	4.331	0.945	1.102	1.496	14	M10 x 25	51	M12	4139	37844	24532	7.982	2.8			
B402211	2 11/16	4.331	0.945	1.102	1.496	14	M10 x 25	51	M12	4238	37844	24532	7.982	2.8			
T402212	2 3/4	4.337	0.945	1.102	1.496	14	M10 x 25	51	M12	4336	37844	24496	7.985	2.7			
T402214	2 7/8	4.528	0.945	1.102	1.496	14	M10 x 25	51	M12	4533	37844	23465	8.073	2.9			
B402215	2 15/16	4.528	0.945	1.102	1.496	14	M10 x 25	51	M12	4632	37844	23465	8.073	2.8			
B402300	3	4.724	0.945	1.102	1.496	14	M10 x 25	51	M12	4730	37844	22487	8.180	3.2			
B402302	3 1/8	4.724	0.945	1.102	1.496	14	M10 x 25	51	M12	4928	37844	22487	8.180	3.0			
T402304	3 1/4	4.921	0.945	1.102	1.496	16	M10 x 25	51	M12	5857	43250	24672	9.111	3.3			
B402306	3 3/8	4.921	0.945	1.102	1.496	16	M10 x 25	51	M12	6082	43250	24672	9.111	3.1			
B402307	3 7/16	5.118	0.945	1.102	1.496	16	M10 x 25	51	M12	6195	43250	23723	9.198	3.4			
B402308	3 1/2	5.118	0.945	1.102	1.496	16	M10 x 25	51	M12	6307	43250	23723	9.198	3.4			
T402312	3 3/4	5.305	0.945	1.102	1.496	18	M10 x 25	51	M12	7603	48656	25748	10.170	3.5			
B402314	3 7/8	5.709	1.024	1.299	1.772	14	M12 x 30	91	M14	9320	57726	26204	11.111	4.8			
T402315	3 15/16	5.709	1.024	1.299	1.772	14	M12 x 30	91	M14	9471	57726	26204	11.111	4.7			
B402400	4	5.843	1.024	1.299	1.772	14	M12 x 30	91	M14	9621	57726	25602	11.147	5			
T402403	4 3/16	6.102	1.024	1.299	1.772	14	M12 x 30	91	M14	10072	57726	24513	11.241	6			
B402407	4 7/16	6.496	1.024	1.299	1.772	16	M12 x 30	91	M14	12198	65972	26317	12.692	6			
B402408	4 1/2	6.496	1.024	1.299	1.772	16	M12 x 30	91	M14	12370	65972	26317	12.692	6			
B402415	4 15/16	7.087	1.339	1.496	1.969	20	M12 x 35	91	M14	16966	82466	23060	12.481	8			
T402500	5	7.087	1.339	1.496	1.969	20	M12 x 35	91	M14	17180	82466	23060	12.481	8			
B402507	5 7/16	7.480	1.339	1.496	1.969	22	M12 x 35	91	M14	20552	90712	24031	13.572	9			
T402508	5 1/2	7.492	1.339	1.496	1.969	22	M12 x 35	91	M14	20788	90712	23993	13.578	8			
B402600	6	8.268	1.339	1.496	1.969	26	M12 x 35	91	M14	26801	107205	25695	15.822	10			
T402607	6 7/16	8.858	1.496	1.732	2.283	22	M14 x 40	138	M16	31764	118419	23702	15.910	14			
B402608	6 1/2	8.858	1.496	1.732	2.283	22	M14 x 40	138	M16	32072	118419	23702	15.910	13			
B402615	6 15/16	9.252	1.496	1.732	2.283	24	M14 x 40	138	M16	37343	129185	24757	17.175	14			
B402700	7	9.252	1.496	1.732	2.283	24	M14 x 40	138	M16	37679	129185	24757	17.175	14			
T402708	7 1/2	9.823	1.811	2.047	2.598	28	M14 x 45	138	M16	47099	150716	22473	17.000	18			
T402714	7 7/8	10.236	1.811	2.047	2.598	30	M14 x 45	138	M16	52986	161481	23106	18.054	19			
T402715	7 15/16	10.504	1.811	2.047	2.598	30	M14 x 45	138	M16	53407	161481	22517	18.203	19			
T402800	8	10.504	1.811	2.047	2.598	30	M14 x 45	138	M16	53827	161481	22517	18.203	19			

### TOLERANCE (T<sub>L</sub>)

Bore diameter machined to D -0/+T<sub>L</sub>  
 T<sub>L</sub> = .05mm for bores up to 50mm  
 .08mm for bores up to 120mm  
 .10mm for bores up to 235mm  
 .13mm for bores up to 375mm  
 .15mm for bores over 375mm

d = Shaft diameter machined to d +0/-T<sub>L</sub>

### B400 – Metric

Part Number	d (mm)	D (mm)	L (mm)	L <sub>1</sub> (mm)	L <sub>5</sub> (mm)	Locking Screws		M <sub>a</sub>	d <sub>B</sub>	M <sub>t</sub>	Th	P <sub>h</sub>	D <sub>N</sub> *	Shipping Weight (kg)
						Qty	Size							
								Torque (Nm)		Thrust (N)	Hub Pressure (N/mm <sup>2</sup> )	Minimum Hub Diameter (mm)		
T401018	18	47	17	20	26	8	M6 x 18	15	M8	302	33561	111	68.4	0.2
T401019	19	47	17	20	26	8	M6 x 18	15	M8	319	33561	111	68.4	0.2
B401020	20	47	17	20	26	8	M6 x 18	15	M8	335	33561	111	68.4	0.2
T401022	22	47	17	20	26	8	M6 x 18	15	M8	369	33561	111	68.4	0.2
B401024	24	50	17	20	26	9	M6 x 18	15	M8	453	37756	118	74.6	0.2
B401025	25	50	17	20	26	9	M6 x 18	15	M8	472	37756	118	74.6	0.2
B401028	28	55	17	20	26	10	M6 x 18	15	M8	587	41952	119	82.4	0.3
B401030	30	55	17	20	26	10	M6 x 18	15	M8	629	41952	119	82.4	0.3
B401032	32	60	17	20	26	12	M6 x 18	15	M8	806	50342	131	94.1	0.3
B401035	35	60	17	20	26	12	M6 x 18	15	M8	881	50342	131	94.1	0.3
B401038	38	65	17	20	26	14	M6 x 18	15	M8	1116	58732	141	106.1	0.3
B401040	40	65	17	20	26	14	M6 x 18	15	M8	1175	58732	141	106.1	0.3
B401042	42	75	20	24	32	12	M8 x 22	35	M10	1892	90071	159	132.3	0.6
B401045	45	75	20	24	32	12	M8 x 22	35	M10	2027	90071	159	132.3	0.5
T401048	48	80	20	24	32	12	M8 x 22	35	M10	2162	90071	149	135.2	0.6
B401050	50	80	20	24	32	12	M8 x 22	35	M10	2252	90071	149	135.2	0.6
B401055	55	85	20	24	32	14	M8 x 22	35	M10	2889	105083	164	153.0	0.6
B401060	60	90	20	24	32	14	M8 x 22	35	M10	3152	105083	155	155.7	0.7
B401065	65	95	20	24	32	16	M8 x 22	35	M10	3903	120095	168	173.9	0.7
B401070	70	110	24	28	38	14	M10 x 25	69	M12	5880	167988	169	202.4	1.2
B401075	75	115	24	28	38	14	M10 x 25	69	M12	6300	167988	161	204.7	1.3
B401080	80	120	24	28	38	14	M10 x 25	69	M12	6720	167988	155	207.5	1.4
T401085	85	125	24	28	38	16	M10 x 25	69	M12	8158	191986	170	231.0	1.4
B401090	90	130	24	28	38	16	M10 x 25	69	M12	8639	191986	163	233.3	1.5
B401095	95	135	24	28	38	18	M10 x 25	69	M12	10259	215984	177	257.9	1.6
B401100	100	145	26	33	45	14	M12 x 30	123	M14	12800	255998	180	281.5	2
B401110	110	155	26	33	45	14	M12 x 30	123	M14	14081	255998	169	284.8	2
B401120	120	165	26	33	45	16	M12 x 30	123	M14	17553	292569	181	321.5	3
B401130	130	180	34	38	50	20	M12 x 35	123	M14	23771	365712	159	316.4	4
B401140	140	190	34	38	50	22	M12 x 35	123	M14	28161	402283	165	344.0	4
T401150	150	200	34	38	50	24	M12 x 35	123	M14	32917	438854	171	372.1	4
B401160	160	210	34	38	50	26	M12 x 35	123	M14	38033	475425	177	400.8	4
B401170	170	225	38	44	58	22	M14 x 40	187	M16	44752	526487	163	404.0	6
B401180	180	235	38	44	58	24	M14 x 40	187	M16	51694	574350	171	436.1	6
B401190	190	250	46	52	66	28	M14 x 45	187	M16	63654	670075	155	431.9	8
B401200	200	260	46	52	66	30	M14 x 45	187	M16	71794	717937	159	458.4	9
B401220	220	285	50	56	72	26	M16 x 50	290	M20	93540	850401	158	500.4	11
B401240	240	305	50	56	72	30	M16 x 50	290	M20	117750	981232	171	566.1	12
B401260	260	325	50	56	72	34	M16 x 50	290	M20	144565	1112063	182	635.2	13
T401280	280	355	60	66	84	32	M18 x 60	397	M22	178059	1271808	158	623.6	19
T401300	300	375	60	66	84	36	M18 x 60	397	M22	214617	1430784	169	689.7	21
T401320	320	405	72	78	98	36	M20 x 70	569	M24	295337	1845919	168	742.3	29
T401340	340	425	72	78	98	36	M20 x 70	569	M24	313810	1845919	160	751.9	31
T401360	360	455	84	90	112	36	M22 x 80	766	M27	410431	2280208	158	798.8	43
T401380	380	475	84	90	112	36	M22 x 80	766	M27	433250	2280208	152	810.4	45
T401400	400	495	84	90	112	36	M22 x 80	766	M27	456041	2280208	145	823.2	47
T401420	420	515	84	90	112	40	M22 x 80	766	M27	532035	2533564	155	892.8	49
T401440	440	545	96	102	126	40	M24 x 90	983	M30	651795	2962675	150	924.4	65
T401460	460	565	96	102	126	40	M24 x 90	983	M30	681406	2962675	145	937.3	67
T401480	480	585	96	102	126	42	M24 x 90	983	M30	746608	3110809	147	978.7	71
T401500	500	605	96	102	126	44	M24 x 90	983	M30	814734	3258942	149	1020.3	72

\*Required hub OD for 1045 h.r. steel hub assuming 45 ksi Yield Point and Stress Reduction Factor C=1 (see page 16 for details)

### B400 – Pilot Bushings

B-LOC pilot bushings: for series B400 Keyless Bushings to provide pre-centering in applications with either straight through hub bores or narrow hubs. Pilot bushings are supplied in sets consisting of three (3) bushings and three (3) longer screws (replacing plated locking screws). For more information refer to [www.fennerdrives.com](http://www.fennerdrives.com) or contact Applications Engineering at 1-800-243-3374.

Recommended pre-centering length in installations without pilot bushings. Provide a minimum .001" clearance (hub concentricity depends on fit clearance).

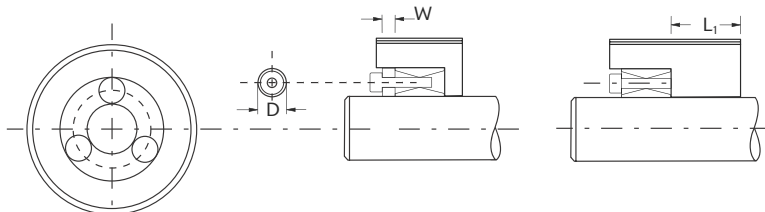

# B-LOC B800

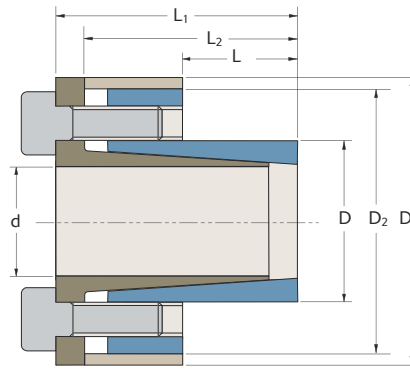
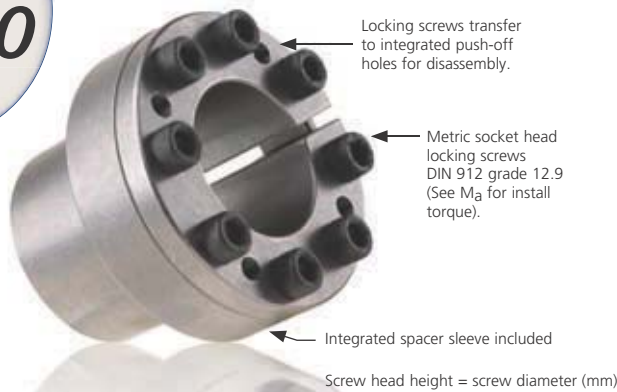

TOLERANCE ( $T_L$ )

Bore diameter machined to  $D - 0/+T_L$   
 $T_L = .002"$  for bores up to 2.559"  
 $.003"$  for bores over 2.559"

$d =$  Shaft diameter machined to  $d + 0/-T_L$ .

## B800 – Inch

Part Number	d (inch)	D (inch)	D <sub>1</sub> (inch)	D <sub>2</sub> (inch)	L (inch)	L <sub>1</sub> (inch)	L <sub>2</sub> (inch)	Locking Screws		M <sub>a</sub> Install Torque (ft lb)	M <sub>t</sub> Torque (ft lb)	Th Thrust (lbs)	P <sub>h</sub> Hub Pressure (psi)	D <sub>N</sub> * Minimum Hub Diameter (inch)	Shipping Weight (lb)		
								Qty	Size							Maximum Transmitted	
																Torque (ft lb)	Thrust (lbs)
B802004	1/4	0.551	0.984	0.906	0.394	0.866	0.748	3	M4 x 10	3.5	16	1572	19217	0.870	0.2		
B802005	5/16	0.591	1.063	0.945	0.472	0.984	0.866	3	M4 x 10	3.5	20	1572	14947	0.834	0.3		
B802006	3/8	0.630	1.142	1.024	0.551	1.063	0.945	4	M4 x 10	3.5	33	2096	16014	0.914	0.4		
T82007	7/16	0.709	1.260	1.102	0.551	1.083	0.945	4	M4 x 10	3.5	38	2096	14235	0.983	0.5		
B802008	1/2	0.906	1.496	1.299	0.551	1.083	0.945	4	M4 x 10	3.5	44	2096	11140	1.166	0.5		
B802010	5/8	0.945	1.732	1.575	0.630	1.437	1.161	3	M6 x 16	12	94	3598	16036	1.372	0.6		
B802012	3/4	1.063	1.929	1.693	0.709	1.555	1.280	4	M6 x 16	12	150	4798	16893	1.577	0.7		
T82014	7/8	1.260	2.126	1.890	0.984	1.850	1.575	4	M6 x 16	12	175	4798	10263	1.589	0.8		
B802015	15/16	1.339	2.205	1.969	0.984	1.850	1.575	6	M6 x 16	12	281	7196	14489	1.869	0.9		
B802100	1	1.339	2.205	1.969	0.984	1.850	1.575	6	M6 x 16	12	300	7196	14489	1.869	0.9		
B802102	1 1/8	1.535	2.402	2.165	0.984	1.850	1.575	6	M6 x 16	12	337	7196	12631	2.049	1.0		
T82103	1 3/16	1.614	2.441	2.244	0.984	1.850	1.575	6	M6 x 16	12	356	7196	12015	2.122	1.1		
B802104	1 1/4	1.693	2.559	2.323	0.984	1.850	1.575	8	M6 x 16	12	500	9595	15275	2.411	1.2		
T82106	1 3/8	1.850	2.677	2.441	1.260	2.126	1.850	8	M6 x 18	12	550	9595	10918	2.370	1.4		
B802107	1 7/16	1.969	2.835	2.598	1.260	2.126	1.850	8	M6 x 18	12	575	9595	10263	2.483	1.5		
B802108	1 1/2	1.969	2.835	2.598	1.260	2.126	1.850	8	M6 x 18	12	600	9595	10263	2.483	1.5		
B802110	1 5/8	2.165	3.071	2.795	1.260	2.126	1.850	8	M6 x 18	12	650	9595	9330	2.672	1.7		
T82111	1 11/16	2.323	3.386	3.150	1.772	2.756	2.441	8	M8 x 22	30	1293	18393	11856	3.042	2.7		
T82112	1 3/4	2.323	3.386	3.150	1.772	2.756	2.441	8	M8 x 22	30	1341	18393	11856	3.042	2.7		
T82114	1 7/8	2.441	3.425	3.189	1.772	2.756	2.441	8	M8 x 22	30	1437	18393	11282	3.154	2.7		
T82115	1 15/16	2.559	3.622	3.386	1.772	2.756	2.441	8	M8 x 22	30	1485	18393	10762	3.266	3.1		
B802200	2	2.795	3.858	3.622	2.165	3.189	2.874	9	M8 x 22	30	1724	20693	9068	3.429	3.8		
T82202	2 1/8	2.795	3.858	3.622	2.165	3.189	2.874	9	M8 x 22	30	1832	20693	9068	3.429	3.8		
T82203	2 3/16	3.031	4.094	3.858	2.165	3.189	2.874	9	M8 x 22	30	1886	20693	8362	3.659	4.2		
T82206	2 3/8	3.031	4.094	3.858	2.165	3.189	2.874	9	M8 x 22	30	2048	20693	8362	3.659	4.2		
B802207	2 7/16	3.307	4.370	4.134	2.165	3.189	2.874	9	M8 x 22	30	2102	20693	7665	3.928	4.9		
B802208	2 1/2	3.307	4.370	4.134	2.165	3.189	2.874	9	M8 x 22	30	2155	20693	7665	3.928	4.9		
T82210	2 5/8	3.543	4.685	4.449	2.559	3.780	3.386	9	M10 x 25	60	3671	33559	9817	4.423	7		
T82212	2 3/4	3.543	4.685	4.449	2.559	3.780	3.386	9	M10 x 25	60	3845	33559	9817	4.423	7		
T82214	2 7/8	3.740	4.961	4.685	2.559	3.780	3.386	9	M10 x 25	60	4020	33559	9301	4.613	7		
T82215	2 15/16	3.740	4.961	4.685	2.559	3.780	3.386	9	M10 x 25	60	4108	33559	9301	4.613	7		
B802300	3	3.740	4.961	4.685	2.559	3.780	3.386	9	M10 x 25	60	4195	33559	9301	4.613	7		
T82302	3 1/8	3.937	5.157	4.921	2.559	3.780	3.386	12	M10 x 25	60	5826	44746	11781	5.147	8		
T82304	3 1/4	4.173	5.394	5.157	2.559	3.780	3.386	12	M10 x 25	60	6059	44746	11114	5.370	8		
T82306	3 3/8	4.173	5.394	5.157	2.559	3.780	3.386	12	M10 x 25	60	6292	44746	11114	5.370	8		
T82307	3 7/16	4.409	5.669	5.394	2.559	3.780	3.386	12	M10 x 25	60	6409	44746	10519	5.595	9		
T82308	3 1/2	4.409	5.669	5.394	2.559	3.780	3.386	12	M10 x 25	60	6525	44746	10519	5.595	9		
T82310	3 5/8	4.409	5.669	5.394	2.559	3.780	3.386	12	M10 x 25	60	6758	44746	10519	5.595	9		
T82312	3 3/4	4.724	5.866	5.591	2.559	3.780	3.386	14	M10 x 25	60	8157	52204	11454	6.129	10		
T82314	3 7/8	4.921	6.299	6.024	2.756	4.213	3.701	12	M12 x 30	105	10808	66940	13092	6.640	12		
B802315	3 15/16	4.921	6.299	6.024	2.756	4.213	3.701	12	M12 x 30	105	10982	66940	13092	6.640	12		
B802400	4	4.921	6.299	6.024	2.756	4.213	3.701	12	M12 x 30	105	11157	66940	13092	6.640	12		
T82404	4 1/4	5.512	6.850	6.614	2.756	4.213	3.701	12	M12 x 30	105	11854	66940	11690	7.190	15		
T82406	4 3/8	5.512	6.850	6.614	2.756	4.213	3.701	12	M12 x 30	105	12203	66940	11690	7.190	15		
T82407	4 7/16	6.102	7.795	7.362	3.543	5.039	4.528	16	M12 x 30	105	16503	89254	10949	7.822	21		
T82408	4 1/2	6.102	7.795	7.362	3.543	5.039	4.528	16	M12 x 30	105	16735	89254	10949	7.822	21		
T82412	4 3/4	6.102	7.795	7.362	3.543	5.039	4.528	16	M12 x 30	105	17665	89254	10949	7.822	21		
T82415	4 15/16	6.496	8.189	7.756	3.543	5.039	4.528	16	M12 x 30	105	18362	89254	10286	8.198	23		

\*Required hub OD for 1045 h.r. steel hub assuming 45 ksi Yield Point and Stress Reduction Factor C=1 (see page 16 for details)



### TOLERANCE (T<sub>L</sub>)

Bore diameter machined to D -0/+T<sub>L</sub>  
 T<sub>L</sub> = .05mm for bores up to 65mm  
 .08mm for bores over 65mm

d = Shaft diameter machined to d +0/-T<sub>L</sub>.

### B800 – Metric

Part Number	d (mm)	D (mm)	D <sub>1</sub> (mm)	D <sub>2</sub> (mm)	L (mm)	L <sub>1</sub> (mm)	L <sub>2</sub> (mm)	Locking Screws		M <sub>a</sub>	M <sub>t</sub>	T <sub>h</sub>	P <sub>h</sub>	D <sub>N</sub> *	Shipping Weight (kg)
								Qty	Size						
										Torque (Nm)	Thrust (N)	Hub Pressure (N/mm <sup>2</sup> )	Minimum Hub Diameter (mm)		
T8006	6	14	25	23	10	22	19	3	M4 x 10	5	22	7285	138	22.6	0.1
T8007	7	15	27	24	12	25	22	3	M4 x 10	5	25	7285	107	21.5	0.1
T8008	8	15	27	24	12	25	22	3	M4 x 10	5	29	7285	107	21.5	0.1
T8009	9	16	29	26	14	27	24	4	M4 x 10	5	44	9713	115	23.6	0.1
B801010	10	16	29	26	14	27	24	4	M4 x 10	5	49	9713	115	23.6	0.1
T8011	11	18	32	28	14	28	24	4	M4 x 10	5	53	9713	102	25.3	0.1
T8012	12	18	32	28	14	28	24	4	M4 x 10	5	58	9713	102	25.3	0.1
B801014	14	23	38	33	14	28	24	4	M4 x 10	5	68	9713	80	29.9	0.1
T8015	15	24	44	40	16	37	30	3	M6 x 16	16	118	15740	109	34.6	0.2
B801016	16	24	44	40	16	37	30	3	M6 x 16	16	126	15740	109	34.6	0.2
B801018	18	26	47	42	18	40	33	4	M6 x 16	16	189	20987	119	38.9	0.3
B801019	19	27	49	43	18	40	33	4	M6 x 16	16	199	20987	115	39.8	0.3
B801020	20	28	50	44	18	40	33	4	M6 x 16	16	210	20987	110	40.6	0.3
B801022	22	32	54	48	25	47	40	4	M6 x 16	16	231	20987	70	40.2	0.4
B801024	24	34	56	50	25	47	40	6	M6 x 16	16	378	31481	98	47.2	0.4
B801025	25	34	56	50	25	47	40	6	M6 x 16	16	394	31481	98	47.2	0.4
T8028	28	39	61	55	25	47	40	6	M6 x 16	16	441	31481	86	51.8	0.4
B801030	30	41	62	57	25	47	40	6	M6 x 16	16	472	31481	81	53.6	0.4
B801032	32	43	65	59	25	47	40	8	M6 x 16	16	672	41975	104	60.8	0.5
T8035	35	47	68	62	32	54	47	8	M6 x 18	16	735	41975	74	59.9	0.5
B801038	38	50	72	66	32	54	47	8	M6 x 18	16	798	41975	70	62.8	0.6
B801040	40	53	75	69	32	54	47	8	M6 x 18	16	839	41975	66	65.7	0.7
T8042	42	55	78	71	32	54	47	8	M6 x 18	16	881	41975	63	67.6	0.7
T8045	45	59	86	80	45	70	62	8	M8 x 22	41	1856	82476	82	77.5	1.1
T8048	48	62	87	81	45	70	62	8	M8 x 22	41	1979	82476	78	80.3	1.1
T8050	50	65	92	86	45	70	62	8	M8 x 22	41	2062	82476	75	83.1	1.3
T8055	55	71	98	92	55	81	73	9	M8 x 22	41	2552	92786	63	87.2	1.6
T8060	60	77	104	98	55	81	73	9	M8 x 22	41	2783	92786	58	93.1	1.8
T8065	65	84	111	105	55	81	73	9	M8 x 22	41	3015	92786	53	99.9	2
T8070	70	90	119	113	65	96	86	9	M10 x 25	81	5203	148643	67	112.2	3
T8075	75	95	126	119	65	96	86	9	M10 x 25	81	5575	148643	64	117.1	3
T8080	80	100	131	125	65	96	86	12	M10 x 25	81	7928	198191	81	130.6	3
T8085	85	106	137	131	65	96	86	12	M10 x 25	81	8423	198191	76	136.3	4
B801090	90	112	144	137	65	96	86	12	M10 x 25	81	8919	198191	72	142.0	4
T8095	95	120	149	142	65	96	86	14	M10 x 25	81	10983	231223	79	155.5	4
T8100	100	125	160	153	70	107	94	12	M12 x 30	142	14851	297024	90	168.5	6
T8110	110	140	174	168	70	107	94	12	M12 x 30	142	16336	297024	80	182.5	7
T8120	120	155	198	187	90	128	115	16	M12 x 30	142	23762	396032	75	198.6	10
T8130	130	165	208	197	90	128	115	16	M12 x 30	142	25742	396032	71	208.1	11

\*Required hub OD for 1045 h.r. steel hub assuming 45 ksi Yield Point and Stress Reduction Factor C=1 (see page 16 for details)

# B-LOC B112



Locking screws transfer to integrated push-off holes for disassembly.

Metric socket head locking screws  
DIN 912 grade 12.9  
(See  $M_a$  for install torque).

Screw head height = screw diameter (mm)

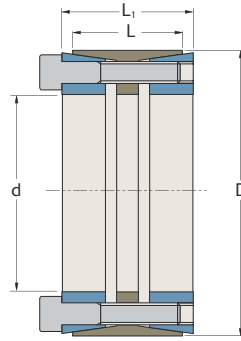

TOLERANCE ( $T_L$ )

Bore diameter machined to  $D -0/+T_L$   
 $T_L = .002"$  for bores up to 4.724"  
 $.003"$  for bores up to 12.008"  
 $.004"$  for bores up to 25.000"  
 $.005"$  for bores over 25.000"

$d =$  shaft diameter machined to  $d +0/-T_L$

## B112 – Heavy Duty – Inch

Part Number	d (inch)	D (inch)	L (inch)	L <sub>1</sub> (inch)	Locking Screws		M <sub>a</sub> Install Torque (ft lb)	M <sub>t</sub> Maximum Transmitted Torque (ft lb)	Th Thrust (lbs)	P <sub>h</sub> Hub Pressure (psi)	DN* Minimum Hub Diameter (inch)	Shipping Weight (lb)
					Qty	Size						
					B122100	1	2.165	1.260	1.575	6	M6 x 35	
T122102	1 1/8	2.165	1.260	1.575	6	M6 x 35	12	675	14390	18656	3.366	1.0
B122103	1 3/16	2.165	1.260	1.575	6	M6 x 35	12	712	14390	18656	3.366	0.9
B122104	1 1/4	2.362	1.732	2.126	7	M6 x 45	12	874	16788	14083	3.266	1.5
B122106	1 3/8	2.362	1.732	2.126	7	M6 x 45	12	962	16788	14083	3.266	1.4
B122107	1 7/16	2.362	1.732	2.126	7	M6 x 45	12	1006	16788	14083	3.266	1.3
B122108	1 1/2	2.953	1.732	2.126	7	M8 x 50	30	2011	32182	21598	4.981	2.4
B122110	1 5/8	2.953	1.732	2.126	7	M8 x 50	30	2179	32182	21598	4.981	2.3
T122111	1 11/16	2.953	1.732	2.126	7	M8 x 50	30	2263	32182	21598	4.981	2.3
B122112	1 3/4	2.953	1.732	2.126	7	M8 x 50	30	2347	32182	21598	4.981	2.1
B122114	1 7/8	3.150	2.205	2.598	8	M8 x 55	30	2873	36779	17881	4.796	2.9
B122115	1 15/16	3.150	2.205	2.598	8	M8 x 55	30	2969	36779	17881	4.796	2.8
B122200	2	3.150	2.205	2.598	8	M8 x 55	30	3065	36779	17881	4.796	2.6
B122202	2 1/8	3.346	2.205	2.598	9	M8 x 55	30	3664	41377	18933	5.241	2.9
B122203	2 3/16	3.346	2.205	2.598	9	M8 x 55	30	3771	41377	18933	5.241	2.8
B122204	2 1/4	3.543	2.205	2.598	10	M8 x 55	30	4310	45974	19868	5.693	3.3
B122206	2 3/8	3.543	2.205	2.598	10	M8 x 55	30	4550	45974	19868	5.693	3.1
B122207	2 7/16	3.740	2.205	2.598	10	M8 x 55	30	4669	45974	18822	5.840	3.6
B122208	2 1/2	3.740	2.205	2.598	10	M8 x 55	30	4789	45974	18822	5.840	3.4
B122209	2 9/16	3.740	2.205	2.598	10	M8 x 55	30	4909	45974	18822	5.840	3.3
B122210	2 5/8	4.331	2.756	3.150	10	M10 x 60	60	8155	74561	20714	7.124	7
T122211	2 11/16	4.331	2.756	3.150	10	M10 x 60	60	8349	74561	20714	7.124	7
B122212	2 3/4	4.331	2.756	3.150	10	M10 x 60	60	8543	74561	20714	7.124	6
B122214	2 7/8	4.331	2.756	3.150	10	M10 x 60	60	8932	74561	20714	7.124	6
B122215	2 15/16	4.724	2.756	3.150	11	M10 x 60	60	10039	82017	20887	7.809	8
B122300	3	4.724	2.756	3.150	11	M10 x 60	60	10252	82017	20887	7.809	7
T122302	3 1/8	4.724	2.756	3.150	11	M10 x 60	60	10679	82017	20887	7.809	7
B122304	3 1/4	4.724	2.756	3.150	11	M10 x 60	60	11107	82017	20887	7.809	7
B122306	3 3/8	5.118	2.756	3.150	12	M10 x 60	60	12582	89474	21033	8.495	8
B122307	3 7/16	5.118	2.756	3.150	12	M10 x 60	60	12815	89474	21033	8.495	8
B122308	3 1/2	5.118	2.756	3.150	12	M10 x 60	60	13048	89474	21033	8.495	8
T122310	3 5/8	5.118	2.756	3.150	12	M10 x 60	60	13514	89474	21033	8.495	7
B122312	3 3/4	5.709	3.543	4.016	11	M12 x 80	105	19172	122699	20688	9.383	13
B122314	3 7/8	5.709	3.543	4.016	11	M12 x 80	105	19811	122699	20688	9.383	12
T122315	3 15/16	5.709	3.543	4.016	11	M12 x 80	105	20130	122699	20688	9.383	13
B122400	4	5.709	3.543	4.016	11	M12 x 80	105	20450	122699	20688	9.383	12
T122404	4 1/4	6.102	3.543	4.016	12	M12 x 80	105	23703	133853	21112	10.152	14
B122406	4 3/8	6.102	3.543	4.016	12	M12 x 80	105	24400	133853	21112	10.152	13
B122407	4 7/16	6.496	3.543	4.016	14	M12 x 80	105	28874	156162	23138	11.468	16
B122408	4 1/2	6.496	3.543	4.016	14	M12 x 80	105	29280	156162	23138	11.468	16
T122412	4 3/4	6.496	3.543	4.016	14	M12 x 80	105	30907	156162	23138	11.468	14
B122415	4 15/16	7.087	4.094	4.567	12	M14 x 90	166	37477	182167	20618	11.626	21
B122500	5	7.087	4.094	4.567	12	M14 x 90	166	37952	182167	20618	11.626	21
B122504	5 1/4	7.480	4.094	4.567	14	M14 x 90	166	46491	212528	22789	13.068	24
B122507	5 7/16	7.480	4.094	4.567	14	M14 x 90	166	48151	212528	22789	13.068	22
T122508	5 1/2	7.480	4.094	4.567	14	M14 x 90	166	48704	212528	22789	13.068	21
T122512	5 3/4	7.874	4.094	4.567	15	M14 x 90	166	54555	227709	23196	13.925	24
B122515	5 15/16	7.874	4.094	4.567	15	M14 x 90	166	56334	227709	23196	13.925	22
B122600	6	8.268	4.094	4.567	16	M14 x 90	166	60722	242890	23564	14.786	26
T122607	6 7/16	8.858	5.276	5.866	14	M16 x 110	257	77782	289982	20051	14.304	40
T122608	6 1/2	8.858	5.276	5.866	14	M16 x 110	257	78537	289982	20051	14.304	39
B122615	6 15/16	9.252	5.276	5.866	15	M16 x 110	257	89810	310695	20569	15.157	40
B122700	7	9.252	5.276	5.866	15	M16 x 110	257	90619	310695	20569	15.157	38
T122704	7 1/4	9.843	5.276	5.866	16	M16 x 110	257	100113	331408	20624	16.149	47
T122707	7 7/16	9.843	5.276	5.866	16	M16 x 110	257	102702	331408	20624	16.149	44
T122708	7 1/2	9.843	5.276	5.866	16	M16 x 110	257	103565	331408	20624	16.149	43
T122712	7 3/4	10.236	5.276	5.866	16	M16 x 110	257	107017	331408	19830	16.428	48
T122715	7 15/16	10.236	5.276	5.866	16	M16 x 110	257	109606	331408	19830	16.428	45
T122800	8	10.236	5.276	5.866	16	M16 x 110	257	110469	331408	19830	16.428	44

**TOLERANCE (T<sub>L</sub>)**

Bore diameter machined to D -0/+T<sub>L</sub>  
 T<sub>L</sub> = .05mm for bores up to 120mm  
 .08mm for bores up to 305mm  
 .10mm for bores up to 635mm  
 .13mm for bores over 635mm

d = shaft diameter machined to d +0/-T<sub>L</sub>.

**B112 – Heavy Duty – Metric**

Part Number	d (mm)	D (mm)	L (mm)	L <sub>1</sub> (mm)	Locking Screws		M <sub>a</sub>	M <sub>t</sub>	Th	Ph	DN*	Shipping Weight (kg)
					Qty	Size	Install Torque (Nm)	Maximum Transmitted		Hub Pressure (N/mm <sup>2</sup> )	Minimum Hub Diameter (mm)	
								Torque (Nm)	Thrust (N)			
T121024	24	55	32	40	6	M6 x 35	16	755	62949	126	84.8	0.4
B121025	25	55	32	40	6	M6 x 35	16	787	62949	126	84.8	0.4
T121028	28	55	32	40	6	M6 x 35	16	881	62949	126	84.8	0.4
B121030	30	55	32	40	6	M6 x 35	16	944	62949	126	84.8	0.4
T121032	32	60	44	54	7	M6 x 45	16	1175	73440	95	82.5	0.6
B121035	35	60	44	54	7	M6 x 45	16	1285	73440	95	82.5	0.6
T121038	38	75	44	54	7	M8 x 45	41	2742	144304	150	127.2	1.0
B121040	40	75	44	54	7	M8 x 45	41	2886	144304	150	127.2	1.0
T121042	42	75	44	54	7	M8 x 45	41	3030	144304	150	127.2	1.0
B121045	45	75	44	54	7	M8 x 45	41	3247	144304	150	127.2	0.9
T121048	48	80	56	66	8	M8 x 55	41	3958	164918	124	122.3	1.3
B121050	50	80	56	66	8	M8 x 55	41	4123	164918	124	122.3	1.2
B121055	55	85	56	66	9	M8 x 55	41	5102	185533	132	133.7	1.3
B121060	60	90	56	66	10	M8 x 55	41	6184	206148	138	145.2	1.4
B121065	65	95	56	66	10	M8 x 55	41	6700	206148	131	148.9	1.5
B121070	70	110	70	80	10	M10 x 60	81	11559	330251	142	180.5	3
T121075	75	115	70	80	10	M10 x 60	81	12384	330251	136	184.1	3
B121080	80	120	70	80	11	M10 x 60	81	14531	363276	143	197.9	3
T121085	85	125	70	80	11	M10 x 60	81	15439	363276	138	201.4	3
B121090	90	130	70	80	12	M10 x 60	81	17834	396302	144	215.2	4
T121095	95	135	70	80	12	M10 x 60	81	18824	396302	139	218.7	4
B121100	100	145	90	102	11	M12 x 80	142	27222	544433	142	238.0	6
B121110	110	155	90	102	12	M12 x 80	142	32666	593927	145	257.5	6
B121120	120	165	90	102	14	M12 x 80	142	41575	692914	159	290.8	7
B121130	130	180	104	116	12	M14 x 90	225	52658	810116	142	295.3	9
B121140	140	190	104	116	14	M14 x 90	225	66159	945135	157	331.9	10
B121150	150	200	104	116	15	M14 x 90	225	75948	1012645	160	353.6	10
B121160	160	210	104	116	16	M14 x 90	225	86412	1080154	162	375.5	11
T121170	170	225	134	149	14	M16 x 110	348	109506	1288307	138	363.1	16
T121180	180	235	134	149	15	M16 x 110	348	124230	1380329	142	384.7	17
T121190	190	250	134	149	16	M16 x 110	348	139873	1472351	142	409.9	20
B121200	200	260	134	149	16	M16 x 110	348	147235	1472351	137	417.0	21
B121220	220	285	134	150	18	M16 x 110	348	182203	1656395	140	463.7	25
B121240	240	305	134	150	20	M16 x 110	348	220853	1840439	146	507.3	27
T121260	260	325	134	150	21	M16 x 110	348	251220	1932460	143	535.8	29
T121280	280	355	165	177	18	M20 x 130	678	360984	2578456	146	591.5	43
T121300	300	375	165	177	20	M20 x 130	678	429743	2864951	154	645.1	47
T121320	320	405	165	177	21	M20 x 130	678	481312	3008198	149	684.2	56
T121340	340	425	165	177	22	M20 x 130	678	535746	3151446	149	717.2	60
T121360	360	455	190	203	21	M22 x 150	915	670526	3725144	143	748.6	80
T121380	380	475	190	203	22	M22 x 150	915	741481	3902532	143	783.1	85
T121400	400	495	190	203	24	M22 x 150	915	851462	4257308	150	839.2	88
T121420	420	515	190	203	24	M22 x 150	915	894035	4257308	144	852.2	92
T121440	440	535	190	203	24	M22 x 150	915	936608	4257308	139	866.0	96
T121460	460	555	190	203	24	M22 x 150	915	979181	4257308	134	880.6	101
T121480	480	575	190	203	28	M22 x 150	915	1192046	4966859	151	977.5	103
T121500	500	595	190	203	28	M22 x 150	915	1241715	4966859	146	990.3	108
T121520	520	615	190	203	30	M22 x 150	915	1383625	5321634	151	1046.7	111
T121540	540	635	190	203	30	M22 x 150	915	1436841	5321634	146	1059.4	114
T121560	560	655	190	203	32	M22 x 150	915	1589395	5676410	151	1115.8	119
T121580	580	675	190	203	32	M22 x 150	915	1646159	5676410	147	1128.5	123
T121600	600	695	190	203	33	M22 x 150	915	1756139	5853798	147	1163.1	128

\*Required hub OD for 1045 h.r. steel hub assuming 45 ksi Yield Point and Stress Reduction Factor C=1 (see page 16 for details)

# B-LOC B115



Locking screws transfer to integrated push-off holes for disassembly.

Metric socket head locking screws  
DIN 912 grade 12.9  
(See  $M_a$  for install torque).

Screw head height = screw diameter (mm)

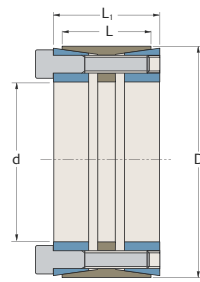

## TOLERANCE ( $T_L$ )

Bore diameter machined to  $D -0/+T_L$   
 $T_L = .002"$  for bores up to 4.724"  
 $T_L = .003"$  for bores up to 12.008"  
 $T_L = .004"$  for bores up to 25.000"  
 $T_L = .005"$  for bores over 25.000"

$T_L = .05\text{mm}$  for bores up to 120mm  
 $T_L = .08\text{mm}$  for bores up to 305mm  
 $T_L = .10\text{mm}$  for bores up to 635mm  
 $T_L = .13\text{mm}$  for bores over 635mm

$d =$  shaft diameter machined to  $d +0/-T_L$

### B115 – Medium Duty – Inch

Part Number	d (inch)	D (inch)	L (inch)	$L_1$ (inch)	Locking Screws		$M_a$ Install Torque (ft lb)	$M_t$ Maximum Transmitted Torque (ft lb)	Th Thrust (lbs)	$P_h$ Hub Pressure (psi)	$D_N^*$ Minimum Hub Diameter (inch)	Shipping Weight (lb)
					Qty	Size						
B152212	2 3/4	4.331	1.969	2.441	8	M10 x 50	60	5261	45913	17858	6.590	5
B152215	2 15/16	4.528	1.969	2.441	8	M10 x 50	60	5620	45913	17079	6.752	5
T152307	3 7/16	5.118	1.969	2.441	11	M10 x 50	60	9042	63131	20777	8.434	7
B152308	3 1/2	5.118	1.969	2.441	11	M10 x 50	60	9207	63131	20777	8.434	6
B152315	3 15/16	5.709	2.362	2.835	10	M12 x 60	105	14086	85858	21111	9.497	9
B152407	4 7/16	6.496	2.362	2.835	11	M12 x 60	105	17462	94444	20408	10.594	12
T152408	4 1/2	6.496	2.362	2.835	11	M12 x 60	105	17708	94444	20408	10.594	11
T152415	4 15/16	7.087	2.559	3.189	14	M12 x 70	105	24729	120202	21162	11.807	15
T152500	5	7.087	2.559	3.189	14	M12 x 70	105	25042	120202	21162	11.807	15
B152507	5 7/16	7.480	2.559	3.228	15	M12 x 70	105	29178	128787	21482	12.576	15
B152515	5 15/16	7.874	2.559	3.228	15	M12 x 70	105	31861	128787	20407	12.841	16
T152600	6	8.268	2.559	3.228	16	M12 x 70	105	34343	137373	20731	13.607	19
T152607	6 7/16	8.858	3.071	3.661	15	M14 x 80	166	47013	175273	20830	14.619	25
B152615	6 15/16	9.252	3.071	3.661	15	M14 x 80	166	50665	175273	19944	14.895	25
B152715	7 15/16	10.236	3.465	4.134	18	M14 x 80	166	69561	210328	18216	15.726	31
T152800	8	10.236	3.465	4.134	18	M14 x 80	166	70109	210328	18216	15.726	32

### B115 – Medium Duty – Metric

Part Number	d (mm)	D (mm)	L (mm)	$L_1$ (mm)	Locking Screws		$M_a$ Install Torque (Nm)	$M_t$ Maximum Transmitted Torque (Nm)	Th Thrust (N)	$P_h$ Hub Pressure (N/mm <sup>2</sup> )	$D_N^*$ Minimum Hub Diameter (mm)	Shipping Weight (kg)
					Qty	Size						
B151070	70	110	50	62	8	M10 x 50	81	7118	203362	123	167.1	2
T151075	75	115	50	62	8	M10 x 50	81	7626	203362	117	171.2	2
T151080	80	120	50	62	10	M10 x 50	81	10168	254202	140	195.5	3
T151090	90	130	50	62	11	M10 x 50	81	12583	279622	143	213.7	3
T151095	95	135	50	62	11	M10 x 50	81	13282	279622	137	217.2	4
B151100	100	145	60	72	10	M12 x 60	142	19048	380966	145	240.9	4
T151110	110	155	60	72	10	M12 x 60	142	20953	380966	136	247.9	4
B151120	120	165	60	72	11	M12 x 60	142	25144	419063	140	268.7	5
T151130	130	180	65	81	14	M12 x 70	142	34668	533353	146	299.4	6
B151140	140	190	65	82	15	M12 x 70	142	40001	571449	148	319.0	7
B151150	150	200	65	82	15	M12 x 70	142	42859	571449	140	325.7	7
B151160	160	210	65	82	16	M12 x 70	142	48764	609546	143	345.1	8
B151170	170	225	78	93	15	M14 x 80	225	66254	779456	144	371.3	11
B151180	180	235	78	93	15	M14 x 80	225	70151	779456	137	378.3	11
B151190	190	250	88	105	16	M14 x 80	225	78985	831420	116	370.4	14
B151200	200	260	88	105	18	M14 x 80	225	93535	935348	126	399.4	15
B151220	220	285	96	111	15	M16 x 90	348	116872	1062472	121	429.5	19
B151240	240	305	96	111	20	M16 x 90	348	169995	1416629	150	517.4	20
T151260	260	325	96	111	21	M16 x 90	348	193370	1487460	148	546.3	22
T151280	280	355	96	111	15	M20 x 90	678	231548	1653915	163	635.3	27
T151300	300	375	96	111	15	M20 x 90	678	248087	1653915	154	646.2	30
T151320	320	405	124	136	20	M20 x 110	678	352835	2205220	150	687.6	44
T151340	340	425	124	136	20	M20 x 110	678	374887	2205220	143	700.7	47
T151360	360	455	140	160	20	M22 x 130	915	491542	2730791	133	718.6	66
T151380	380	475	140	160	20	M22 x 130	915	518850	2730791	127	733.9	69
T151400	400	495	140	160	22	M22 x 130	915	600774	3003871	134	786.3	72
T151420	420	515	140	160	24	M22 x 130	915	688159	3276950	141	839.7	75
T151440	440	535	140	160	24	M22 x 130	915	720929	3276950	135	854.1	78
T151460	460	555	140	160	24	M22 x 130	915	753698	3276950	131	869.1	82
T151480	480	575	140	160	25	M22 x 130	915	819237	3413489	131	902.9	84
T151500	500	595	140	160	25	M22 x 130	915	853372	3413489	127	918.4	88
T151520	520	615	140	160	28	M22 x 130	915	994008	3823108	137	989.7	91
T151540	540	635	140	160	28	M22 x 130	915	1032239	3823108	133	1004.5	94
T151560	560	655	140	160	30	M22 x 130	915	1146932	4096187	138	1057.6	97
T151580	580	675	140	160	30	M22 x 130	915	1187894	4096187	134	1072.2	100
T151600	600	695	140	160	30	M22 x 130	915	1228856	4096187	130	1087.3	103



Locking screws transfer to integrated push-off holes for disassembly.

Metric socket head locking screws  
DIN 912 grade 12.9  
(See  $M_a$  for install torque).

Screw head height = screw diameter (mm)

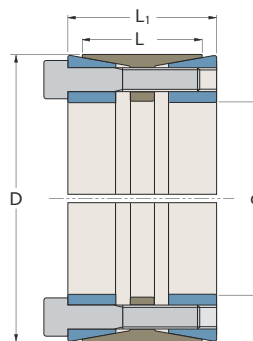

TOLERANCE ( $T_L$ )

Bore diameter machined to  $D -0/+T_L$   
 $T_L =$  .064mm for bores up to 285mm  
 .08mm for bores up to 355mm  
 .09mm for bores up to 615mm  
 .10mm for bores up to 675mm  
 .13mm for bores over 675mm

$d =$  shaft diameter machined to  $d +0/-T_L$

## B113 – Extra Heavy Duty

Part Number	d (mm)	D (mm)	L (mm)	L <sub>1</sub> (mm)	Locking Screws		M <sub>a</sub> Install Torque (Nm)	M <sub>t</sub> Maximum Transmitted Torque (Nm)	Th Thrust (N)	P <sub>h</sub> Hub Pressure (N/mm <sup>2</sup> )	DN* Minimum Hub Diameter (mm)	Shipping Weight (kg)
					Qty	Size						
					T131180	180	285	205	231	14	M22 x 180	915
T131200	200	305	205	233	16	M22 x 180	915	283878	2838783	149	514.2	67
T131220	220	325	205	229	16	M22 x 180	915	312251	2838783	141	531.3	73
T131240	240	355	208	240	16	M24 x 180	1180	400322	3335957	147	593.2	88
T131260	260	375	208	240	18	M24 x 180	1180	487873	3752951	156	652.5	93
T131280	280	405	208	238	20	M24 x 180	1180	583812	4169946	163	724.6	110
T131300	300	425	208	240	20	M24 x 180	1180	625491	4169946	153	729.8	117
T131320	320	455	250	280	18	M27 x 220	1763	803261	5020549	149	766.5	161
T131340	340	475	250	285	20	M27 x 220	1763	948338	5578387	156	825.0	170
T131360	360	495	250	283	22	M27 x 220	1763	1104503	6136226	164	893.0	177
T131380	380	515	250	280	22	M27 x 220	1763	1165912	6136226	160	912.8	186
T131400	400	535	250	280	22	M27 x 220	1763	1227243	6136226	152	914.8	192
T131420	420	555	250	285	24	M27 x 220	1763	1405717	6694065	160	981.7	202
T131440	440	575	250	285	24	M27 x 220	1763	1472708	6694065	154	992.8	210
T131460	460	595	250	285	24	M27 x 220	1763	1539615	6694065	149	1005.0	220
T131480	480	615	250	285	28	M27 x 220	1763	1874374	7809742	168	1129.8	227
T131500	500	635	250	280	28	M27 x 220	1763	1952432	7809742	163	1139.0	233
T131520	520	655	250	285	28	M27 x 220	1763	2030489	7809742	158	1149.3	244
T131540	540	675	250	280	30	M27 x 220	1763	2259264	8367581	164	1217.7	251
T131560	560	695	250	280	30	M27 x 220	1763	2342897	8367581	160	1227.8	260

\*Required hub OD for 1045 h.r. steel hub assuming 45 ksi Yield Point and Stress Reduction Factor C=1 (see page 16 for details)



# Trantorque GT

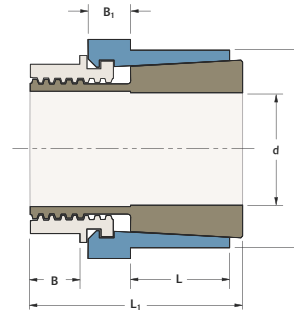
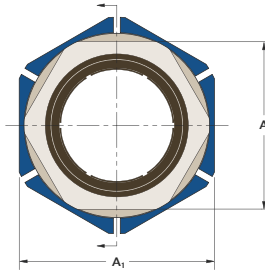

TOLERANCE ( $T_L$ )

$T_L$  for shaft and bore is  $\pm .003"$  for all sizes

## Trantorque GT Inch

Part Number	d (inch)	D (inch)	L (inch)	L <sub>1</sub> (inch)	Wrench Size				M <sub>a</sub> Install Torque (ft lb)	M <sub>t</sub> Maximum Transmitted Torque (ft lb)	Th Thrust (lbs)	P <sub>h</sub> Hub Pressure (psi)	DN* Minimum Hub Diameter (inch)	Shipping Weight (lb)
					A (inch)	A <sub>1</sub> (inch)	B (inch)	B <sub>1</sub> (inch)						
6202120	5/8	1 1/2	3/4	1 1/2	1 1/4	1 1/2	5/16	5/16	100	146	3300	11000	1.925	0.5
6202140	11/16	1 1/2	3/4	1 1/2	1 1/4	1 1/2	5/16	5/16	100	167	3850	11000	1.925	0.5
6202160	3/4	1 1/2	3/4	1 1/2	1 1/4	1 1/2	5/16	5/16	100	208	4400	11000	1.925	0.5
6202190	13/16	1 3/4	7/8	1 7/8	1 1/2	1 3/4	7/16	3/8	125	217	4950	9400	2.163	0.7
6202200	7/8	1 3/4	7/8	1 7/8	1 1/2	1 3/4	7/16	3/8	125	233	5500	9400	2.163	0.7
6202220	15/16	1 3/4	7/8	1 7/8	1 1/2	1 3/4	7/16	3/8	125	258	6050	9400	2.163	0.7
6202240	1	1 3/4	7/8	1 7/8	1 1/2	1 3/4	7/16	3/8	125	292	6600	9400	2.163	0.7
6202270	1 1/16	2	1	2 1/4	1 3/4	2	1/2	9/16	167	333	7000	7800	2.383	1.1
6202280	1 1/8	2	1	2 1/4	1 3/4	2	1/2	9/16	167	383	7500	7800	2.383	1.1
6202300	1 3/16	2	1	2 1/4	1 3/4	2	1/2	9/16	167	433	8000	7800	2.383	1.1
6202320	1 1/4	2	1	2 1/4	1 3/4	2	1/2	9/16	167	500	8500	7800	2.383	1.1
6202350	1 5/16	2 3/8	1 1/2	2 3/4	2	2 3/8	9/16	1/2	192	517	9000	6500	2.747	1.1
6202360	1 3/8	2 3/8	1 1/2	2 3/4	2	2 3/8	9/16	1/2	192	533	9500	6500	2.747	1.9
6202380	1 7/16	2 3/8	1 1/2	2 3/4	2	2 3/8	9/16	1/2	192	558	10000	6500	2.747	1.8
6202400	1 1/2	2 3/8	1 1/2	2 3/4	2	2 3/8	9/16	1/2	192	583	10500	6500	2.747	1.8
6202430	1 9/16	2 5/8	1 11/16	3 1/8	2 1/4	2 5/8	9/16	11/16	234	667	11000	5500	2.968	2.5
6202440	1 5/8	2 5/8	1 11/16	3 1/8	2 1/4	2 5/8	9/16	11/16	234	708	11750	5500	2.968	2.4
6202460	1 11/16	2 5/8	1 11/16	3 1/8	2 1/4	2 5/8	9/16	11/16	234	771	12250	5500	2.968	2.4
6202480	1 3/4	2 5/8	1 11/16	3 1/8	2 1/4	2 5/8	9/16	11/16	234	833	12750	5500	2.968	2.3
6202510	1 13/16	2 7/8	2	3 9/16	2 1/2	2 7/8	5/8	3/4	409	917	13250	4200	3.157	3.5
6202520	1 7/8	2 7/8	2	3 9/16	2 1/2	2 7/8	5/8	3/4	409	979	14000	4200	3.157	3.4
6202540	1 15/16	2 7/8	2	3 9/16	2 1/2	2 7/8	5/8	3/4	409	1063	14500	4200	3.157	3.3
6202560	2	2 7/8	2	3 9/16	2 1/2	2 7/8	5/8	3/4	409	1167	15000	4200	3.157	3.2
6202562	2 1/16	3 1/8	2 1/8	3 3/4	2 3/4	3 1/8	5/8	13/16	442	1188	15100	3500	3.378	3.8
6202564	2 1/8	3 1/8	2 1/8	3 3/4	2 3/4	3 1/8	5/8	13/16	442	1208	15200	3500	3.378	4
6202566	2 3/16	3 1/8	2 1/8	3 3/4	2 3/4	3 1/8	5/8	13/16	442	1229	15250	3500	3.378	3.8
6202568	2 1/4	3 1/8	2 1/8	3 3/4	2 3/4	3 1/8	5/8	13/16	442	1250	15275	3500	3.378	3.7
6202570	2 5/16	3 3/8	2 1/4	3 7/8	3	3 3/8	11/16	3/4	467	1271	15330	2800	3.592	4.4
6202572	2 3/8	3 3/8	2 1/4	3 7/8	3	3 3/8	11/16	3/4	467	1292	15400	2800	3.592	4.5
6202574	2 7/16	3 3/8	2 1/4	3 7/8	3	3 3/8	11/16	3/4	467	1313	15480	2800	3.592	4.4
6202576	2 1/2	3 3/8	2 1/4	3 7/8	3	3 3/8	11/16	3/4	467	1333	15550	2800	3.592	4.2
6202580	2 9/16	3 5/8	2 3/8	4 1/16	3 1/4	3 5/8	11/16	13/16	500	1354	15620	2400	3.824	5
6202582	2 5/8	3 5/8	2 3/8	4 1/16	3 1/4	3 5/8	11/16	13/16	500	1375	15680	2400	3.824	5.1
6202584	2 11/16	3 5/8	2 3/8	4 1/16	3 1/4	3 5/8	11/16	13/16	500	1396	15750	2400	3.824	5
6202586	2 3/4	3 5/8	2 3/8	4 1/16	3 1/4	3 5/8	11/16	13/16	500	1417	15800	2400	3.824	5
6202590	2 13/16	3 7/8	2 1/2	4 1/4	3 1/2	3 7/8	3/4	13/16	550	1438	15900	2300	4.078	6
6202592	2 7/8	3 7/8	2 1/2	4 1/4	3 1/2	3 7/8	3/4	13/16	550	1458	15950	2300	4.078	6
6202594	2 15/16	3 7/8	2 1/2	4 1/4	3 1/2	3 7/8	3/4	13/16	550	1479	16025	2300	4.078	6
6202596	3	3 7/8	2 1/2	4 1/4	3 1/2	3 7/8	3/4	13/16	550	1500	16150	2300	4.078	5



Trantorque GT metric sizes are plated with RoHS compliant clear Zinc.

TOLERANCE ( $T_L$ )

$T_L$  for shaft and bore is  $\pm .08\text{mm}$  for all sizes

**Trantorque GT Metric**

Part Number	d (mm)	D (mm)	L (mm)	L <sub>1</sub> (mm)	Wrench Size		B (mm)	B <sub>1</sub> (mm)	M <sub>a</sub> Install Torque (Nm)	M <sub>t</sub>	Th	P <sub>h</sub> Hub Pressure (N/mm <sup>2</sup> )	DN*	Shipping Weight (kg)
					A (mm)	A <sub>1</sub> (inch)				Maximum Transmitted				
										Torque (Nm)	Thrust (kN)			
6202800	15	38.0	19.1	38.1	32	1 1/2	8.0	8.9	136	180	13.4	76	48.8	0.2
6202803	16	38.0	19.1	38.1	32	1 1/2	8.0	8.9	136	198	15.0	76	48.8	0.2
6202804	17	38.0	19.1	38.1	32	1 1/2	8.0	8.9	136	220	17.0	76	48.8	0.2
6202805	18	38.0	19.1	38.1	32	1 1/2	8.0	8.9	136	265	18.1	76	48.8	0.2
6202808	19	38.0	19.1	38.1	32	1 1/2	8.0	8.9	136	282	19.9	76	48.8	0.2
6202811	20	45.0	22.2	47.6	38	1 3/4	11.1	9.5	170	290	21.0	65	55.7	0.4
6202815	22	45.0	22.2	47.6	38	1 3/4	11.1	9.5	170	315	24.1	65	55.7	0.4
6202820	24	45.0	22.2	47.6	38	1 3/4	11.1	9.5	170	380	27.2	65	55.7	0.3
6202825	25	45.0	22.2	47.6	38	1 3/4	11.1	9.5	170	390	28.7	65	55.7	0.3
6202830	28	51.0	25.4	57.2	46	2	12.7	14.3	225	495	32.6	54	60.8	0.5
6202835	30	51.0	25.4	57.2	46	2	12.7	14.3	225	580	35.4	54	60.8	0.5
6202840	32	51.0	25.4	57.2	46	2	12.7	14.3	225	680	38.2	54	60.8	0.5
6202845	34	60.5	38.1	69.9	50	2 3/8	14.3	12.7	260	710	41.0	45	70.0	0.9
6202850	35	60.5	38.1	69.9	50	2 3/8	14.3	12.7	260	725	42.4	45	70.0	0.9
6202855	36	60.5	38.1	69.9	50	2 3/8	14.3	12.7	260	750	43.8	45	70.0	0.9
6202860	38	60.5	38.1	69.9	50	2 3/8	14.3	12.7	260	790	46.6	45	70.0	0.8
6202865	40	67.0	42.9	79.4	60	2 5/8	14.3	17.4	316	900	49.7	38	75.8	1.2
6202870	42	67.0	42.9	79.4	60	2 5/8	14.3	17.4	316	1000	53.3	38	75.8	1.1
6202876	45	73.0	50.8	90.5	65	2 7/8	15.9	19.1	554	1170	57.5	29	80.2	1.6
6202880	48	73.0	50.8	90.5	65	2 7/8	15.9	19.1	554	1355	62.9	29	80.2	1.6
6202885	50	73.0	50.8	90.5	65	2 7/8	15.9	19.1	554	1510	65.7	29	80.2	1.5
6202900	55	80.0	54.0	95.3	70	3 1/8	15.9	20.7	600	1650	67.8	24	86.4	1.8
6202910	60	86.0	57.2	98.4	75	3 3/8	17.5	19.1	635	1740	68.7	19	91.4	2
6202920	65	92.0	60.3	103.2	82	3 5/8	17.5	20.7	680	1930	69.5	17	97.2	2
6202930	70	92.0	60.3	103.2	82	3 5/8	17.5	20.7	680	1920	70.4	17	97.2	2
6202940	75	100.0	63.5	108.0	90	3 7/8	19.1	20.7	750	2000	71.5	16	97.2	3

\*Required hub OD for 1045 h.r. steel hub assuming 45 ksi Yield Point and Stress Reduction Factor C=1 (see page 16 for details)

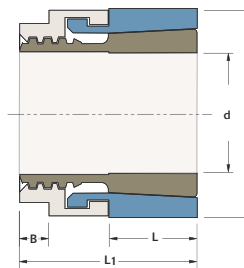
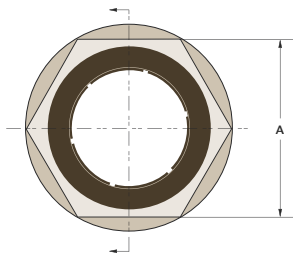

TOLERANCE ( $T_L$ )  
 $T_L$  for shaft and bore is  $\pm .0015''$   
for all sizes

**Trantorque Mini Inch**

Part Number	d (inch)	D (inch)	L (inch)	L <sub>1</sub> (inch)	Wrench Size		M <sub>a</sub>	M <sub>t</sub>	T <sub>h</sub>	P <sub>h</sub>	DN*	Shipping Weight (lb)
					A (inch)	B (inch)	Install Torque (in lb)	Maximum Transmitted		Hub Pressure (psi)		
								Torque (in lb)	Thrust (lbs)			
6202102	1/8	5/8	3/8	3/4	1/2	1/8	125	100	700	5200	0.702	0.1
6202103	3/16	5/8	3/8	3/4	1/2	1/8	125	100	700	5200	0.702	0.1
6202105	1/4	5/8	3/8	3/4	1/2	1/8	125	150	790	5200	0.702	0.1
6202107	5/16	3/4	7/16	7/8	5/8	1/8	150	200	890	3700	0.814	0.1
6202109	3/8	3/4	7/16	7/8	5/8	1/8	150	250	925	3700	0.814	0.1
6202110	7/16	7/8	1/2	1	3/4	3/16	175	300	950	2700	0.929	0.1
6202112	1/2	7/8	1/2	1	3/4	3/16	175	350	980	2700	0.929	0.1
6202114	9/16	1	5/8	1 1/8	7/8	3/16	200	400	990	1800	1.041	0.1
6202115	5/8	1	5/8	1 1/8	7/8	3/16	200	450	1000	1800	1.041	0.1
6202119	3/4	1 1/4	3/4	1 3/8	1 1/16	1/4	700	1500	2000	8000	1.496	0.3

\*Required hub OD for 1045 h.r. steel hub assuming 45 ksi Yield Point and Stress Reduction Factor C=1 (see page 16 for details)



Trantorque Mini metric sizes are plated with RoHS compliant clear Zinc.

TOLERANCE (T<sub>L</sub>)

T<sub>L</sub> for shaft and bore is ± .04mm for all sizes

**Trantorque Mini Metric**

Part Number	d (mm)	D (mm)	L (mm)	L <sub>1</sub> (mm)	Wrench Size		M <sub>a</sub>	M <sub>t</sub>	Th	P <sub>h</sub>	DN*	Shipping Weight (kg)
					A (mm)	B (mm)	Install Torque (Nm)	Maximum Transmitted		Hub Pressure (N/mm <sup>2</sup> )	Minimum Hub Diameter (mm)	
								Torque (Nm)	Thrust (kN)			
6202640	3	16.0	9.5	19.1	13	3.2	14.1	12	3.2	36	18.0	0.05
6202645	4	16.0	9.5	19.1	13	3.2	14.1	12	3.2	36	18.0	0.05
6202650	5	16.0	9.5	19.1	13	3.2	14.1	12	3.2	36	18.0	0.05
6202660	6	16.0	9.5	19.1	13	3.2	14.1	16	3.4	36	18.0	0.05
6202670	7	19.0	11.1	22.2	16	3.2	17	20	3.5	26	20.7	0.05
6202680	8	19.0	11.1	22.2	16	3.2	17	23	4.0	26	20.7	0.05
6202690	9	19.0	11.1	22.2	16	3.2	17	26	4.1	26	20.7	0.05
6202700	10	22.5	12.7	25.7	19	4.8	19.8	30	4.2	19	23.9	0.05
6202710	11	22.5	12.7	25.7	19	4.8	19.8	34	4.2	19	23.9	0.05
6202720	12	22.5	12.7	25.7	19	4.8	19.8	39	4.3	19	23.9	0.05
6202740	14	25.5	15.9	28.6	22	4.8	22.6	44	4.4	12	26.5	0.05
6202750	15	25.5	15.9	28.6	22	4.8	22.6	45	4.4	12	26.5	0.05
6202760	16	25.5	15.9	28.6	22	4.8	22.6	50	4.5	12	26.5	0.05
6202770	17	32.0	19.1	34.9	27	6.4	80	170	8.9	55	38.3	0.14

\*Required hub OD for 1045 h.r. steel hub assuming 45 ksi Yield Point and Stress Reduction Factor C=1 (see page 16 for details)

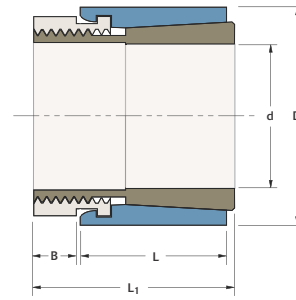
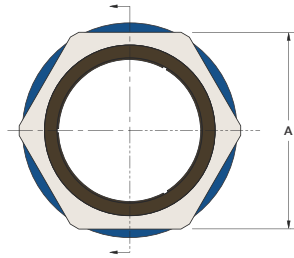

TOLERANCE ( $T_L$ )  
 $T_L$  for shaft and bore is  $\pm .003''$   
for all sizes

**Trantorque OE Inch**

Part Number	d (inch)	D (inch)	L (inch)	L <sub>1</sub> (inch)	Wrench Size		M <sub>a</sub> Install Torque (ft lb)	M <sub>t</sub> Maximum Transmitted Torque (ft lb)	Th Thrust (lbs)	P <sub>h</sub> Hub Pressure (psi)	DN* Minimum Hub Diameter (inch)	Shipping Weight (lb)
					A (inch)	B (inch)						
6410069	11/16	1 1/4	7/8	1 3/16	1 1/8	1/4	82	158	5517	13380	1.698	0.2
6410075	3/4	1 1/4	7/8	1 3/16	1 1/8	1/4	82	172	5517	13380	1.698	0.2
6410081	13/16	1 3/8	15/16	1 9/32	1 1/4	9/32	111	227	6713	13814	1.888	0.2
6410088	7/8	1 3/8	15/16	1 9/32	1 1/4	9/32	111	245	6713	13814	1.888	0.2
6410094	15/16	1 1/2	1	1 3/8	1 3/8	5/16	137	292	7471	13212	2.030	0.4
6410100	1	1 1/2	1	1 3/8	1 3/8	5/16	137	311	7471	13212	2.030	0.3
6410106	1 1/16	1 5/8	1 1/16	1 1/2	1 1/2	3/8	155	340	7686	11808	2.126	0.4
6410113	1 1/8	1 5/8	1 1/16	1 1/2	1 1/2	3/8	155	360	7686	11808	2.126	0.4
6410119	1 3/16	1 3/4	1 1/8	1 5/8	1 5/8	7/16	177	402	8114	10932	2.242	0.5
6410125	1 1/4	1 3/4	1 1/8	1 5/8	1 5/8	7/16	177	423	8114	10932	2.242	0.5
6410131	1 5/16	1 7/8	1 3/16	1 23/32	1 3/4	15/32	196	454	8301	9889	2.344	0.6
6410138	1 3/8	1 7/8	1 3/16	1 23/32	1 3/4	15/32	196	476	8301	9889	2.344	0.6
6410144	1 7/16	2	1 1/4	1 13/16	1 7/8	1/2	196	463	7723	8194	2.404	0.7
6410150	1 1/2	2	1 1/4	1 13/16	1 7/8	1/2	196	483	7723	8194	2.404	0.6

TOLERANCE ( $T_L$ )  
 $T_L$  for shaft and bore is  $\pm .08\text{mm}$   
for all sizes

**Trantorque OE Metric**

Part Number	d (mm)	D (mm)	L (mm)	L <sub>1</sub> (mm)	Wrench Size		M <sub>a</sub> Install Torque (Nm)	M <sub>t</sub> Maximum Transmitted Torque (Nm)	Th Thrust (kN)	P <sub>h</sub> Hub Pressure (N/mm <sup>2</sup> )	DN* Minimum Hub Diameter (mm)	Shipping Weight (kg)
					A (mm)	B (mm)						
TTQM1732	17	32	22	30	30	6	110	208	25	92	43.5	0.1
TTQM1832	18	32	22	30	30	6	110	221	25	92	43.5	0.1
TTQM1932	19	32	22	30	30	6	110	233	25	92	43.5	0.1
TTQM2035	20	35	24	33	32	7	150	298	30	94	47.9	0.1
TTQM2235	22	35	24	33	32	7	150	328	30	94	47.9	0.1
TTQM2438	24	38	25	35	36	8	185	398	33	93	51.7	0.2
TTQM2538	25	38	25	35	36	8	185	415	33	93	51.7	0.2
TTQM2845	28	45	29	41	46	11	240	505	36	73	57.3	0.3
TTQM3045	30	45	29	41	46	11	240	541	36	73	57.3	0.3
TTQM3250	32	50	30	44	50	12	265	590	37	65	61.9	0.4
TTQM3550	35	50	30	44	50	12	265	645	37	65	61.9	0.3

\*Required hub OD for 1045 h.r. steel hub assuming 45 ksi Yield Point and Stress Reduction Factor C=1 (see page 16 for details)



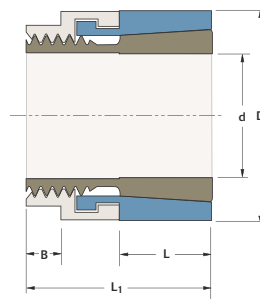
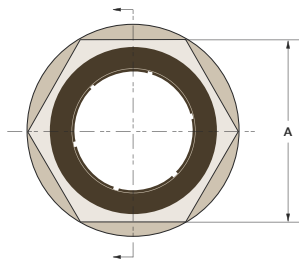

TOLERANCE ( $T_L$ )

$T_L$  for shaft and bore is  $\pm .0015^*$   
for all sizes

**Trantorque OE Mini Inch**

Part Number	d (inch)	D (inch)	L (inch)	L1 (inch)	Wrench Size		Ma Install Torque (in lb)	Mt Maximum Transmitted Torque (in lb)	Th Thrust (lbs)	Ph Hub Pressure (psi)	DN* Minimum Hub Diameter (inch)	Shipping Weight (lb)
					A (inch)	B (inch)						
					Maximum Transmitted							
6410013	1/8	5/8	3/8	3/4	1/2	1/8	90	62	1000	11316	0.808	0.1
6410019	3/16	5/8	3/8	3/4	1/2	1/8	90	94	1000	11316	0.808	0.1
6410025	1/4	5/8	3/8	3/4	1/2	1/8	90	125	1000	11316	0.808	0.1
6410031	5/16	3/4	7/16	7/8	5/8	1/8	250	351	2245	18147	1.150	0.1
6410038	3/8	3/4	7/16	7/8	5/8	1/8	250	421	2245	18147	1.150	0.1
6410044	7/16	7/8	1/2	1	3/4	3/16	390	645	2946	17864	1.332	0.1
6410050	1/2	7/8	1/2	1	3/4	3/16	390	737	2946	17864	1.332	0.1
6410056	9/16	1	5/8	1 1/8	7/8	3/16	585	1066	3790	16084	1.453	0.1
6410063	5/8	1	5/8	1 1/8	7/8	3/16	585	1184	3790	16084	1.453	0.1

TOLERANCE ( $T_L$ )

$T_L$  for shaft and bore is  $\pm .04$ mm  
for all sizes

**Trantorque OE Mini Metric**

Part Number	d (mm)	D (mm)	L (mm)	L1 (mm)	Wrench Size		Ma Install Torque (Nm)	Mt Maximum Transmitted Torque (Nm)	Th Thrust (kN)	Ph Hub Pressure (N/mm <sup>2</sup> )	DN* Minimum Hub Diameter (mm)	Shipping Weight (kg)
					A (mm)	B (mm)						
					Maximum Transmitted							
TTQM0316	3	16	10	19	13	3	10	7	4	73	20.3	0.02
TTQM0416	4	16	10	19	13	3	10	9	4	73	20.3	0.02
TTQM0516	5	16	10	19	13	3	10	11	4	73	20.3	0.02
TTQM0616	6	16	10	19	13	3	10	13	4	73	20.3	0.02
TTQM0720	7	20	11	22	16	3	28	35	10	119	30.0	0.03
TTQM0820	8	20	11	22	16	3	28	40	10	119	30.0	0.03
TTQM0920	9	20	11	22	16	3	28	45	10	119	30.0	0.03
TTQM1023	10	23	13	26	19	5	44	65	13	116	34.1	0.05
TTQM1123	11	23	13	26	19	5	44	72	13	116	34.1	0.05
TTQM1223	12	23	13	26	19	5	44	79	13	116	34.1	0.05
TTQM1426	14	26	16	29	22	5	66	118	17	107	37.3	0.06
TTQM1526	15	26	16	29	22	5	66	126	17	107	37.3	0.06
TTQM1626	16	26	16	29	22	5	66	135	17	107	37.3	0.06

\*Required hub OD for 1045 h.r. steel hub assuming 45 ksi Yield Point and Stress Reduction Factor C=1 (see page 16 for details)

# Trantorque EN

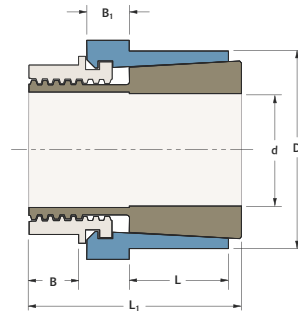
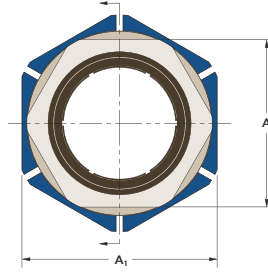

TOLERANCE ( $T_L$ )  
 $T_L$  for shaft and bore is  $\pm .003"$   
 for all sizes

## Trantorque EN Inch

Part Number	d (inch)	D (inch)	L (inch)	L <sub>1</sub> (inch)	Wrench Size		B (inch)	B <sub>1</sub> (inch)	M <sub>a</sub> Install Torque (ft lb)	M <sub>t</sub> Maximum Transmitted Torque (ft lb)	Th Thrust (lbs)	P <sub>h</sub> Hub Pressure (psi)	DN* Minimum Hub Diameter (inch)	Shipping Weight (lb)
					A (inch)	A <sub>1</sub> (inch)								
6202120EN	5/8	1 1/2	3/4	1 1/2	1 1/4	1 1/2	5/16	5/16	100	73	1650	5500	1.696	0.5
6202140EN	11/16	1 1/2	3/4	1 1/2	1 1/4	1 1/2	5/16	5/16	100	83	1925	5500	1.696	0.5
6202160EN	3/4	1 1/2	3/4	1 1/2	1 1/4	1 1/2	5/16	5/16	100	104	2200	5500	1.696	0.5
6202190EN	13/16	1 3/4	7/8	1 7/8	1 1/2	1 3/4	7/16	3/8	125	108	2475	4700	1.943	0.6
6202200EN	7/8	1 3/4	7/8	1 7/8	1 1/2	1 3/4	7/16	3/8	125	117	2750	4700	1.943	0.6
6202220EN	15/16	1 3/4	7/8	1 7/8	1 1/2	1 3/4	7/16	3/8	125	129	3025	4700	1.943	0.6
6202240EN	1	1 3/4	7/8	1 7/8	1 1/2	1 3/4	7/16	3/8	125	146	3300	4700	1.943	0.6
6202270EN	1 1/16	2	1	2 1/4	1 3/4	2	1/2	9/16	167	167	3500	3900	2.182	1
6202280EN	1 1/8	2	1	2 1/4	1 3/4	2	1/2	9/16	167	192	3750	3900	2.182	1
6202300EN	1 3/16	2	1	2 1/4	1 3/4	2	1/2	9/16	167	217	4000	3900	2.182	1
6202320EN	1 1/4	2	1	2 1/4	1 3/4	2	1/2	9/16	167	250	4250	3900	2.182	1
6202350EN	1 5/16	2 3/8	1 1/2	2 3/4	2	2 3/8	9/16	1/2	192	258	4500	3250	2.553	1.6
6202360EN	1 3/8	2 3/8	1 1/2	2 3/4	2	2 3/8	9/16	1/2	192	267	4750	3250	2.553	1.6
6202380EN	1 7/16	2 3/8	1 1/2	2 3/4	2	2 3/8	9/16	1/2	192	279	5000	3250	2.553	1.6
6202400EN	1 1/2	2 3/8	1 1/2	2 3/4	2	2 3/8	9/16	1/2	192	292	5250	3250	2.553	1.6
6202430EN	1 9/16	2 5/8	1 11/16	3 1/8	2 1/4	2 5/8	9/16	11/16	234	333	5500	2750	2.791	2.3
6202440EN	1 5/8	2 5/8	1 11/16	3 1/8	2 1/4	2 5/8	9/16	11/16	234	354	5875	2750	2.791	2.3
6202460EN	1 11/16	2 5/8	1 11/16	3 1/8	2 1/4	2 5/8	9/16	11/16	234	385	6125	2750	2.791	2.3
6202480EN	1 3/4	2 5/8	1 11/16	3 1/8	2 1/4	2 5/8	9/16	11/16	234	417	6375	2750	2.791	2.3
6202510EN	1 13/16	2 7/8	2	3 9/16	2 1/2	2 7/8	5/8	3/4	409	458	6625	2100	3.012	3
6202520EN	1 7/8	2 7/8	2	3 9/16	2 1/2	2 7/8	5/8	3/4	409	490	7000	2100	3.012	3
6202540EN	1 15/16	2 7/8	2	3 9/16	2 1/2	2 7/8	5/8	3/4	409	531	7250	2100	3.012	3
6202560EN	2	2 7/8	2	3 9/16	2 1/2	2 7/8	5/8	3/4	409	583	7500	2100	3.012	3
6202562EN	2 1/16	3 1/8	2 1/8	3 3/4	2 3/4	3 1/8	5/8	13/16	442	594	7550	1750	3.249	3.7
6202564EN	2 1/8	3 1/8	2 1/8	3 3/4	2 3/4	3 1/8	5/8	13/16	442	604	7600	1750	3.249	3.7
6202566EN	2 3/16	3 1/8	2 1/8	3 3/4	2 3/4	3 1/8	5/8	13/16	442	615	7625	1750	3.249	3.7
6202568EN	2 1/4	3 1/8	2 1/8	3 3/4	2 3/4	3 1/8	5/8	13/16	442	625	7638	1750	3.249	3.7
6202570EN	2 5/16	3 3/8	2 1/4	3 7/8	3	3 3/8	11/16	3/4	467	635	7665	1400	3.482	4.2
6202572EN	2 3/8	3 3/8	2 1/4	3 7/8	3	3 3/8	11/16	3/4	467	646	7700	1400	3.482	4.2
6202574EN	2 7/16	3 3/8	2 1/4	3 7/8	3	3 3/8	11/16	3/4	467	656	7740	1400	3.482	4.2
6202576EN	2 1/2	3 3/8	2 1/4	3 7/8	3	3 3/8	11/16	3/4	467	667	7775	1400	3.482	4.2
6202580EN	2 9/16	3 5/8	2 3/8	4 1/16	3 1/4	3 5/8	11/16	13/16	500	677	7810	1200	3.723	4.8
6202582EN	2 5/8	3 5/8	2 3/8	4 1/16	3 1/4	3 5/8	11/16	13/16	500	688	7840	1200	3.723	4.8
6202584EN	2 11/16	3 5/8	2 3/8	4 1/16	3 1/4	3 5/8	11/16	13/16	500	698	7875	1200	3.723	4.8
6202586EN	2 3/4	3 5/8	2 3/8	4 1/16	3 1/4	3 5/8	11/16	13/16	500	708	7900	1200	3.723	4.8
6202590EN	2 13/16	3 7/8	2 1/2	4 1/4	3 1/2	3 7/8	3/4	13/16	550	719	7950	1150	3.975	6
6202592EN	2 7/8	3 7/8	2 1/2	4 1/4	3 1/2	3 7/8	3/4	13/16	550	729	7975	1150	3.975	6
6202594EN	2 15/16	3 7/8	2 1/2	4 1/4	3 1/2	3 7/8	3/4	13/16	550	740	8013	1150	3.975	6
6202596EN	3	3 7/8	2 1/2	4 1/4	3 1/2	3 7/8	3/4	13/16	550	750	8075	1150	3.975	6

TOLERANCE (T<sub>L</sub>)

T<sub>L</sub> for shaft and bore is ± .08mm  
for all sizes

**Trantorque EN Metric**

Part Number	d (mm)	D (mm)	L (mm)	L <sub>1</sub> (mm)	Wrench Size		B (mm)	B <sub>1</sub> (mm)	M <sub>a</sub> Install Torque (Nm)	M <sub>t</sub>	Th	P <sub>h</sub> Hub Pressure (N/mm <sup>2</sup> )	DN* Minimum Hub Diameter (mm)	Shipping Weight (kg)
					A (mm)	A <sub>1</sub> (inch)				Maximum Transmitted				
										Torque (Nm)	Thrust (kN)			
6202800EN	15	38.0	19.1	38.1	32	1 1/2	8.0	8.9	136	90	6.7	38	43.0	0.2
6202803EN	16	38.0	19.1	38.1	32	1 1/2	8.0	8.9	136	99	7.5	38	43.0	0.2
6202804EN	17	38.0	19.1	38.1	32	1 1/2	8.0	8.9	136	110	8.5	38	43.0	0.2
6202805EN	18	38.0	19.1	38.1	32	1 1/2	8.0	8.9	136	133	9.1	38	43.0	0.2
6202808EN	19	38.0	19.1	38.1	32	1 1/2	8.0	8.9	136	141	10.0	38	43.0	0.2
6202811EN	20	45.0	22.2	47.6	38	1 3/4	11.1	9.5	170	145	11.0	32	49.9	0.4
6202815EN	22	45.0	22.2	47.6	38	1 3/4	11.1	9.5	170	158	12.1	32	49.9	0.4
6202820EN	24	45.0	22.2	47.6	38	1 3/4	11.1	9.5	170	190	13.6	32	49.9	0.3
6202825EN	25	45.0	22.2	47.6	38	1 3/4	11.1	9.5	170	195	14.4	32	49.9	0.3
6202830EN	28	51.0	25.4	57.2	46	2	12.7	14.3	225	248	16.3	27	55.6	0.5
6202835EN	30	51.0	25.4	57.2	46	2	12.7	14.3	225	290	17.7	27	55.6	0.5
6202840EN	32	51.0	25.4	57.2	46	2	12.7	14.3	225	340	19.1	27	55.6	0.5
6202845EN	34	60.5	38.1	69.9	50	2 3/8	14.3	12.7	260	355	20.5	22	64.9	0.9
6202850EN	35	60.5	38.1	69.9	50	2 3/8	14.3	12.7	260	363	21.2	22	64.9	0.9
6202855EN	36	60.5	38.1	69.9	50	2 3/8	14.3	12.7	260	375	21.9	22	64.9	0.9
6202860EN	38	60.5	38.1	69.9	50	2 3/8	14.3	12.7	260	395	23.3	22	64.9	0.8
6202865EN	40	67.0	42.9	79.4	60	2 5/8	14.3	17.4	316	450	24.9	19	71.2	1.2
6202870EN	42	67.0	42.9	79.4	60	2 5/8	14.3	17.4	316	500	26.7	19	71.2	1.1
6202876EN	45	73.0	50.8	90.5	65	2 7/8	15.9	19.1	554	585	28.8	15	76.5	1.6
6202880EN	48	73.0	50.8	90.5	65	2 7/8	15.9	19.1	554	678	31.5	15	76.6	1.6
6202885EN	50	73.0	50.8	90.5	65	2 7/8	15.9	19.1	554	755	32.9	15	76.6	1.5
6202900EN	55	80.0	54.0	95.3	70	3 1/8	15.9	20.7	600	825	33.9	12	83.2	1.8
6202910EN	60	86.0	57.2	98.4	75	3 3/8	17.5	19.1	635	870	34.4	10	88.8	2
6202920EN	65	92.0	60.3	103.2	82	3 5/8	17.5	20.7	680	965	34.8	8	94.4	2
6202930EN	70	92.0	60.3	103.2	82	3 5/8	17.5	20.7	680	960	35.2	8	94.4	2
6202940EN	75	100.0	63.5	108.0	90	3 7/8	19.1	20.7	750	1000	35.8	8	102.6	3

\*Required hub OD for 1045 h.r. steel hub assuming 45 ksi Yield Point and Stress Reduction Factor C=1 (see page 16 for details)

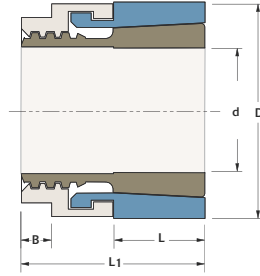
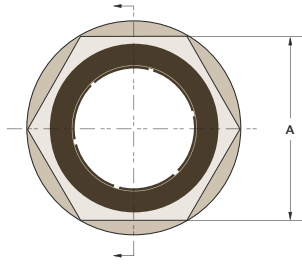

TOLERANCE ( $T_L$ )

$T_L$  for shaft and bore is  $\pm .0015"$   
for all sizes

**Trantorque EN Mini Inch**

Part Number	d (inch)	D (inch)	L (inch)	L <sub>1</sub> (inch)	Wrench Size		M <sub>a</sub>	M <sub>t</sub>	Th	P <sub>h</sub>	DN*	Shipping Weight (lb)
					A (inch)	B (inch)	Install Torque (in lb)	Maximum Transmitted		Hub Pressure (psi)	Minimum Hub Diameter (inch)	
								Torque (in lb)	Thrust (lbs)			
6202103EN	3/16	5/8	3/8	3/4	1/2	1/8	125	50	350	2600	0.662	0.1
6202105EN	1/4	5/8	3/8	3/4	1/2	1/8	125	75	395	2600	0.662	0.1
6202107EN	5/16	3/4	7/16	7/8	5/8	1/8	150	100	445	1850	0.781	0.1
6202109EN	3/8	3/4	7/16	7/8	5/8	1/8	150	125	463	1850	0.781	0.1
6202110EN	7/16	7/8	1/2	1	3/4	3/16	175	150	475	1350	0.902	0.1
6202112EN	1/2	7/8	1/2	1	3/4	3/16	175	175	490	1350	0.902	0.1
6202114EN	9/16	1	5/8	1 1/8	7/8	3/16	200	200	495	900	1.020	0.1
6202115EN	5/8	1	5/8	1 1/8	7/8	3/16	200	225	500	900	1.020	0.2
6202119EN	3/4	1 1/4	3/4	1 3/8	1 1/16	1/4	700	750	1000	4000	1.367	0.2

\*Required hub OD for 1045 h.r. steel hub assuming 45 ksi Yield Point and Stress Reduction Factor C=1 (see page 16 for details)

TOLERANCE (T<sub>L</sub>)

T<sub>L</sub> for shaft and bore is ± .04mm  
for all sizes

**Trantorque EN Mini Metric**

Part Number	d (mm)	D (mm)	L (mm)	L <sub>1</sub> (mm)	Wrench Size		Ma	Mt	Th	Ph	DN*	Shipping Weight (kg)
					A (mm)	B (mm)	Maximum Transmitted		Hub Pressure (N/mm <sup>2</sup> )	Minimum Hub Diameter (mm)		
							Install Torque (Nm)	Torque (Nm)			Thrust (kN)	
6202650EN	5	16.0	9.5	19.1	13	3.2	14.1	6	1.6	18	16.9	0.05
6202660EN	6	16.0	9.5	19.1	13	3.2	14.1	8	1.7	18	16.9	0.05
6202670EN	7	19.0	11.1	22.2	16	3.2	17	10	1.8	13	19.8	0.05
6202680EN	8	19.0	11.1	22.2	16	3.2	17	12	2.0	13	19.8	0.05
6202690EN	9	19.0	11.1	22.2	16	3.2	17	13	2.1	13	19.8	0.05
6202700EN	10	22.5	12.7	25.7	19	4.8	19.8	15	2.1	9	23.2	0.05
6202710EN	11	22.5	12.7	25.7	19	4.8	19.8	17	2.1	9	23.2	0.05
6202720EN	12	22.5	12.7	25.7	19	4.8	19.8	20	2.2	9	23.2	0.05
6202740EN	14	25.5	15.9	28.6	22	4.8	22.6	22	2.2	6	26.0	0.05
6202750EN	15	25.5	15.9	28.6	22	4.8	22.6	23	2.2	6	26.0	0.05
6202760EN	16	25.5	15.9	28.6	22	4.8	22.6	25	2.3	6	26.0	0.05
6202770EN	17	32.0	19.1	34.9	27	6.4	22.6	85	4.5	28	35.0	0.14

\*Required hub OD for 1045 h.r. steel hub assuming 45 ksi Yield Point and Stress Reduction Factor C=1 (see page 16 for details)



# Trantorque SS

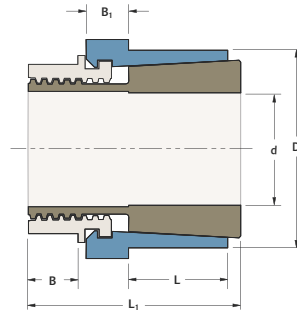
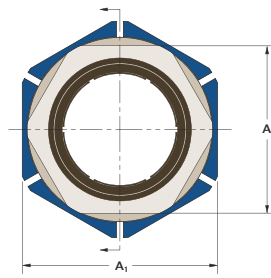

TOLERANCE ( $T_1$ )  
 $T_1$  for shaft and bore is  $\pm .003$ "  
 for all sizes

## Trantorque SS Inch

Part Number	d (inch)	D (inch)	L (inch)	L <sub>1</sub> (inch)	Wrench Size				M <sub>a</sub> Install Torque (ft lb)	Maximum Transmitted		P <sub>h</sub> Hub Pressure (psi)	DN* Minimum Hub Diameter (inch)	Shipping Weight (lb)
					A (inch)	A <sub>1</sub> (inch)	B (inch)	B <sub>1</sub> (inch)		Torque (ft lb)	Thrust (lbs)			
6990120	5/8	1 1/2	3/4	1 1/2	1 1/4	1 1/2	5/16	5/16	100	44	990	3300	1.614	0.5
6990140	11/16	1 1/2	3/4	1 1/2	1 1/4	1 1/2	5/16	5/16	100	50	1155	3300	1.614	0.5
6990160	3/4	1 1/2	3/4	1 1/2	1 1/4	1 1/2	5/16	5/16	100	63	1320	3300	1.614	0.5
6990190	13/16	1 3/4	7/8	1 7/8	1 1/2	1 3/4	7/16	3/8	125	65	1485	2820	1.863	0.7
6990200	7/8	1 3/4	7/8	1 7/8	1 1/2	1 3/4	7/16	3/8	125	70	1650	2820	1.863	0.7
6990220	15/16	1 3/4	7/8	1 7/8	1 1/2	1 3/4	7/16	3/8	125	78	1815	2820	1.863	0.7
6990240	1	1 3/4	7/8	1 7/8	1 1/2	1 3/4	7/16	3/8	125	88	1980	2820	1.863	0.7
6990270	1 1/16	2	1	2 1/4	1 3/4	2	1/2	9/16	167	100	2100	2340	2.107	1.1
6990280	1 1/8	2	1	2 1/4	1 3/4	2	1/2	9/16	167	115	2250	2340	2.107	1.1
6990300	1 3/16	2	1	2 1/4	1 3/4	2	1/2	9/16	167	130	2400	2340	2.107	1.1
6990320	1 1/4	2	1	2 1/4	1 3/4	2	1/2	9/16	167	150	2550	2340	2.107	1.1
6990350	1 5/16	2 3/8	1 1/2	2 3/4	2	2 3/8	9/16	1/2	192	155	2700	1950	2.480	1.1
6990360	1 3/8	2 3/8	1 1/2	2 3/4	2	2 3/8	9/16	1/2	192	160	2850	1950	2.480	1.9
6990380	1 7/16	2 3/8	1 1/2	2 3/4	2	2 3/8	9/16	1/2	192	168	3000	1950	2.480	1.8
6990400	1 1/2	2 3/8	1 1/2	2 3/4	2	2 3/8	9/16	1/2	192	175	3150	1950	2.480	1.8
6990430	1 9/16	2 5/8	1 11/16	3 1/8	2 1/4	2 5/8	9/16	11/16	234	200	3300	1650	2.723	2.5
6990440	1 5/8	2 5/8	1 11/16	3 1/8	2 1/4	2 5/8	9/16	11/16	234	213	3525	1650	2.723	2.4
6990460	1 11/16	2 5/8	1 11/16	3 1/8	2 1/4	2 5/8	9/16	11/16	234	231	3675	1650	2.723	2.4
6990480	1 3/4	2 5/8	1 11/16	3 1/8	2 1/4	2 5/8	9/16	11/16	234	250	3825	1650	2.723	2.3
6990510	1 13/16	2 7/8	2	3 9/16	2 1/2	2 7/8	5/8	3/4	409	275	3975	1260	2.957	3.5
6990520	1 7/8	2 7/8	2	3 9/16	2 1/2	2 7/8	5/8	3/4	409	294	4200	1260	2.957	3.4
6990540	1 15/16	2 7/8	2	3 9/16	2 1/2	2 7/8	5/8	3/4	409	319	4350	1260	2.957	3.3
6990560	2	2 7/8	2	3 9/16	2 1/2	2 7/8	5/8	3/4	409	350	4500	1260	2.957	3.2
6990562	2 1/16	3 1/8	2 1/8	3 3/4	2 3/4	3 1/8	5/8	13/16	442	356	4530	1050	3.200	3.8
6990564	2 1/8	3 1/8	2 1/8	3 3/4	2 3/4	3 1/8	5/8	13/16	442	363	4560	1050	3.200	4
6990566	2 3/16	3 1/8	2 1/8	3 3/4	2 3/4	3 1/8	5/8	13/16	442	369	4575	1050	3.200	3.8
6990568	2 1/4	3 1/8	2 1/8	3 3/4	2 3/4	3 1/8	5/8	13/16	442	375	4585	1050	3.200	3.7
6990570	2 5/16	3 3/8	2 1/4	3 7/8	3	3 3/8	11/16	3/4	467	381	4600	840	3.439	4.4
6990572	2 3/8	3 3/8	2 1/4	3 7/8	3	3 3/8	11/16	3/4	467	388	4620	840	3.439	4.5
6990574	2 7/16	3 3/8	2 1/4	3 7/8	3	3 3/8	11/16	3/4	467	394	4645	840	3.439	4.4
6990576	2 1/2	3 3/8	2 1/4	3 7/8	3	3 3/8	11/16	3/4	467	400	4665	840	3.439	4.2
6990580	2 9/16	3 5/8	2 3/8	4 1/16	3 1/4	3 5/8	11/16	13/16	500	406	4680	720	3.683	5
6990582	2 5/8	3 5/8	2 3/8	4 1/16	3 1/4	3 5/8	11/16	13/16	500	413	4705	720	3.683	5.1
6990584	2 11/16	3 5/8	2 3/8	4 1/16	3 1/4	3 5/8	11/16	13/16	500	419	4725	720	3.683	5
6990586	2 3/4	3 5/8	2 3/8	4 1/16	3 1/4	3 5/8	11/16	13/16	500	425	4740	720	3.683	4.8
6990590	2 13/16	3 7/8	2 1/2	4 1/4	3 1/2	3 7/8	3/4	13/16	550	431	4770	690	3.935	6.0
6990592	2 7/8	3 7/8	2 1/2	4 1/4	3 1/2	3 7/8	3/4	13/16	550	438	4785	690	3.935	5.9
6990594	2 15/16	3 7/8	2 1/2	4 1/4	3 1/2	3 7/8	3/4	13/16	550	444	4810	690	3.935	5.5
6990596	3	3 7/8	2 1/2	4 1/4	3 1/2	3 7/8	3/4	13/16	550	450	4845	690	3.935	5.4

TOLERANCE (T<sub>L</sub>)

T<sub>L</sub> for shaft and bore is ± .08mm  
for all sizes

**Trantorque SS Metric**

Part Number	d (mm)	D (mm)	L (mm)	L <sub>1</sub> (mm)	Wrench Size		B (mm)	B <sub>1</sub> (mm)	M <sub>a</sub> Install Torque (Nm)	M <sub>t</sub> Maximum Transmitted Torque (Nm)	T <sub>h</sub> Thrust (kN)	P <sub>h</sub> Hub Pressure (N/mm <sup>2</sup> )	D <sub>N</sub> * Minimum Hub Diameter (mm)	Shipping Weight (kg)
					A (mm)	A <sub>1</sub> (inch)								
					Maximum Transmitted									
6990800	15	38.0	19.1	38.1	32	1 1/2	8.0	8.9	136	54	4.0	23	40.9	0.2
6990803	16	38.0	19.1	38.1	32	1 1/2	8.0	8.9	136	59	4.5	23	40.9	0.2
6990804	17	38.0	19.1	38.1	32	1 1/2	8.0	8.9	136	66	5.1	23	40.9	0.2
6990805	18	38.0	19.1	38.1	32	1 1/2	8.0	8.9	136	80	5.4	23	40.9	0.2
6990808	19	38.0	19.1	38.1	32	1 1/2	8.0	8.9	170	85	6.0	23	40.9	0.2
6990811	20	45.0	22.2	47.6	38	1 3/4	11.1	9.5	170	87	6.3	19	47.8	0.4
6990815	22	45.0	22.2	47.6	38	1 3/4	11.1	9.5	170	95	7.2	19	47.8	0.4
6990820	24	45.0	22.2	47.6	38	1 3/4	11.1	9.5	170	114	8.2	19	47.8	0.3
6990825	25	45.0	22.2	47.6	38	1 3/4	11.1	9.5	170	117	8.6	19	47.8	0.3
6990830	28	51.0	25.4	57.2	46	2	12.7	14.3	225	149	9.8	16	53.7	0.5
6990835	30	51.0	25.4	57.2	46	2	12.7	14.3	225	174	10.6	16	53.7	0.5
6990840	32	51.0	25.4	57.2	46	2	12.7	14.3	225	204	11.5	16	53.7	0.5
6990845	34	60.5	38.1	69.9	50	2 3/8	14.3	12.7	260	213	12.3	13	63.1	0.9
6990850	35	60.5	38.1	69.9	50	2 3/8	14.3	12.7	260	218	12.7	13	63.1	0.9
6990855	36	60.5	38.1	69.9	50	2 3/8	14.3	12.7	260	225	13.1	13	63.1	0.9
6990860	38	60.5	38.1	69.9	50	2 3/8	14.3	12.7	260	237	14.0	13	63.1	0.8
6990865	40	67.0	42.9	79.4	60	2 5/8	14.3	17.4	316	270	14.9	11	69.4	1.2
6990870	42	67.0	42.9	79.4	60	2 5/8	14.3	17.4	316	300	16.0	11	69.4	1.1
6990876	45	73.0	50.8	90.5	65	2 7/8	15.9	19.1	554	351	17.3	9	75.1	1.6
6990880	48	73.0	50.8	90.5	65	2 7/8	15.9	19.1	554	407	18.9	9	75.1	1.6
6990885	50	73.0	50.8	90.5	65	2 7/8	15.9	19.1	554	453	19.7	9	75.1	1.5
6990900	55	80.0	54.0	95.3	70	3 1/8	15.9	20.7	600	495	20.3	7	81.8	1.8
6990910	60	86.0	57.2	98.4	75	3 3/8	17.5	19.1	635	522	20.6	6	87.7	2
6990920	65	92.0	60.3	103.2	82	3 5/8	17.5	20.7	680	549	20.9	5	93.5	2
6990930	70	92.0	60.3	103.2	82	3 5/8	17.5	20.7	680	576	21.1	5	93.5	2
6990940	75	100.0	63.5	108.0	90	3 7/8	19.1	20.7	750	600	21.5	5	101.6	3

\*Required hub OD for 1045 h.r. steel hub assuming 45 ksi Yield Point and Stress Reduction Factor C=1 (see page 16 for details)

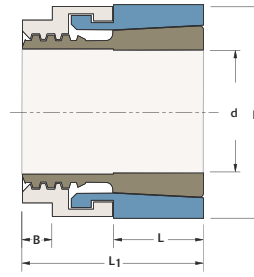
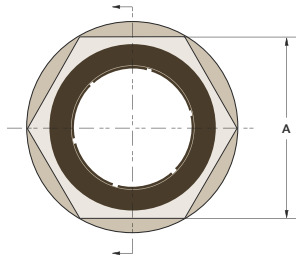

TOLERANCE ( $T_L$ )

$T_L$  for shaft and bore is  $\pm .0015''$  for all sizes

**Trantorque SS Mini Inch**

Part Number	d (inch)	D (inch)	L (inch)	L <sub>1</sub> (inch)	Wrench Size		M <sub>a</sub> Install Torque (in lb)	M <sub>t</sub> Maximum Transmitted		Th Thrust (lbs)	P <sub>h</sub> Hub Pressure (psi)	D <sub>N</sub> * Minimum Hub Diameter (inch)	Shipping Weight (lb)
					A (inch)	B (inch)		Torque (in lb)	Thrust (lbs)				
6990103	3/16	5/8	3/8	3/4	1/2	1/8	125	30	210	1560	0.647	0.1	
6990105	1/4	5/8	3/8	3/4	1/2	1/8	125	45	235	1560	0.647	0.1	
6990107	5/16	3/4	7/16	7/8	5/8	1/8	150	60	265	1110	0.769	0.1	
6990109	3/8	3/4	7/16	7/8	5/8	1/8	150	75	280	1110	0.769	0.1	
6990110	7/16	7/8	1/2	1	3/4	3/16	175	90	285	810	0.891	0.1	
6990112	1/2	7/8	1/2	1	3/4	3/16	175	105	295	810	0.891	0.1	
6990114	9/16	1	5/8	1 1/8	7/8	3/16	200	120	295	540	1.021	0.1	
6990115	5/8	1	5/8	1 1/8	7/8	3/16	200	135	300	540	1.021	0.1	
6990119	3/4	1 1/4	3/4	1 3/8	1 1/16	1/4	700	450	600	2400	1.319	0.1	

TOLERANCE ( $T_L$ )

$T_L$  for shaft and bore is  $\pm .04\text{mm}$  for all sizes

**Trantorque SS Mini Metric**

Part Number	d (mm)	D (mm)	L (mm)	L <sub>1</sub> (mm)	Wrench Size		M <sub>a</sub> Install Torque (Nm)	M <sub>t</sub> Maximum Transmitted		Th Thrust (kN)	P <sub>h</sub> Hub Pressure (N/mm <sup>2</sup> )	D <sub>N</sub> * Minimum Hub Diameter (mm)	Shipping Weight (kg)
					A (mm)	B (mm)		Torque (Nm)	Thrust (kN)				
6990650	5	16.0	9.5	19.1	13	3.2	14.1	4	1.0	11	16.6	0.05	
6990660	6	16.0	9.5	19.1	13	3.2	14.1	5	1.0	11	16.6	0.05	
6990670	7	19.0	11.1	22.2	16	3.2	17	6	1.2	8	19.5	0.05	
6990680	8	19.0	11.1	22.2	16	3.2	17	7	1.2	8	19.5	0.05	
6990690	9	19.0	11.1	22.2	16	3.2	17	8	1.2	8	19.5	0.05	
6990700	10	22.5	12.7	25.7	19	4.8	19.8	9	1.2	6	22.9	0.05	
6990710	11	22.5	12.7	25.7	19	4.8	19.8	10	1.3	6	22.9	0.05	
6990720	12	22.5	12.7	25.7	19	4.8	19.8	12	1.3	6	22.9	0.05	
6990740	14	25.5	15.9	28.6	22	4.8	22.6	13	1.3	4	25.8	0.05	
6990750	15	25.5	15.9	28.6	22	4.8	22.6	14	1.3	4	25.8	0.05	
6990760	16	25.5	15.9	28.6	22	4.8	22.6	15	1.3	4	25.8	0.05	
6990770	17	32.0	19.1	34.9	27	6.4	80	46	2.4	17	33.8	0.14	

\*Required hub OD for 1045 h.r. steel hub assuming 45 ksi Yield Point and Stress Reduction Factor C=1 (see page 16 for details)

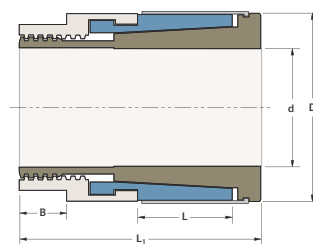
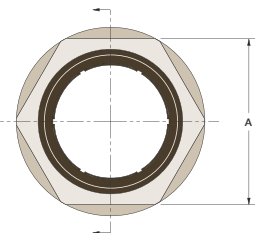

TOLERANCE ( $T_L$ )

Bore diameter machined to  $D \pm T_L$   
 $T_L = .0015^*$  for Part Numbers  
 6980103 – 6980119  
 $T_L = .003^*$  for all other Trantorque NT

**Trantorque NT Inch**

Part Number	d (inch)	D (inch)	L (inch)	L <sub>1</sub> (inch)	Wrench Size A (inch)	B (inch)	M <sub>a</sub>	M <sub>t</sub>		P <sub>H</sub>	D <sub>N</sub> *
							Install Torque (in lb)	Torque (ft lb)	Thrust (lbs)		
6980103	3/16	5/8	3/8	1 1/16	1/2	1/8	125	6	490	3640	0.678
6980105	1/4	5/8	3/8	1 1/16	1/2	1/8	125	9	553	3640	0.678
6980107	5/16	3/4	7/16	1 3/16	5/8	1/8	150	12	623	2590	0.794
6980109	3/8	3/4	7/16	1 3/16	5/8	1/8	150	15	648	2590	0.794
6980110	7/16	7/8	1/2	1 5/16	3/4	3/16	175	18	665	1890	0.913
6980112	1/2	7/8	1/2	1 5/16	3/4	3/16	175	20	686	1890	0.913
6980114	9/16	1	5/8	1 7/16	7/8	3/16	200	23	693	1260	1.028
6980115	5/8	1	5/8	1 7/16	7/8	3/16	200	26	700	1260	1.028
6980119	3/4	1 1/4	3/4	1 11/16	1 1/16	1/4	700	88	1400	5600	1.417
6980120X	5/8	1 1/2	11/16	1 13/16	1 1/4	5/16	1200	102	2310	7700	1.783
6980140X	11/16	1 1/2	11/16	1 13/16	1 1/4	5/16	1200	117	2695	7700	1.783
6980160X	3/4	1 1/2	11/16	1 13/16	1 1/4	5/16	1200	146	3080	7700	1.783
6980190X	13/16	1 3/4	13/16	2 3/16	1 1/2	7/16	1500	152	3465	6850	2.040
6980200X	7/8	1 3/4	13/16	2 3/16	1 1/2	7/16	1500	163	3850	6850	2.040
6980220X	15/16	1 3/4	13/16	2 3/16	1 1/2	7/16	1500	181	4235	6850	2.040
6980240X	1	1 3/4	13/16	2 3/16	1 1/2	7/16	1500	204	4620	6850	2.040
6980270X	1 1/16	2	15/16	2 9/16	1 3/4	1/2	2000	233	4900	5460	2.259
6980280X	1 1/8	2	15/16	2 9/16	1 3/4	1/2	2000	268	5250	5460	2.259
6980300X	1 3/16	2	15/16	2 9/16	1 3/4	1/2	2000	292	5600	5460	2.259
6980320X	1 1/4	2	15/16	2 9/16	1 3/4	1/2	2000	350	5950	5460	2.259
6980350X	1 5/16	2 3/8	1 7/16	3 3/32	2	9/16	2300	362	6300	4550	2.629
6980360X	1 3/8	2 3/8	1 7/16	3 3/32	2	9/16	2300	373	6650	4550	2.629
6980380X	1 7/16	2 3/8	1 7/16	3 3/32	2	9/16	2300	391	7000	4550	2.629
6980400X	1 1/2	2 3/8	1 7/16	3 3/32	2	9/16	2300	408	7350	4550	2.629
6980430X	1 9/16	2 5/8	1 5/8	3 15/32	2 1/4	9/16	2800	467	7700	3850	2.860
6980440X	1 5/8	2 5/8	1 5/8	3 15/32	2 1/4	9/16	2800	496	8225	3850	2.860
6980460X	1 11/16	2 5/8	1 5/8	3 15/32	2 1/4	9/16	2800	540	8575	3850	2.860
6980480X	1 3/4	2 5/8	1 5/8	3 15/32	2 1/4	9/16	2800	583	8925	3850	2.860
6980510X	1 13/16	2 7/8	1 15/16	4 3/64	2 1/2	5/8	4900	642	9275	2940	3.069
6980520X	1 7/8	2 7/8	1 15/16	4 3/64	2 1/2	5/8	4900	685	9800	2940	3.069
6980540X	1 15/16	2 7/8	1 15/16	4 3/64	2 1/2	5/8	4900	744	10150	2940	3.069
6980560X	2	2 7/8	1 15/16	4 3/64	2 1/2	5/8	4900	817	10500	2940	3.069

\*Required hub OD for 1045 h.r. steel hub assuming 45 ksi Yield Point and Stress Reduction Factor C=1 (see page 16 for details)  
 Consult factory for weights and availability.



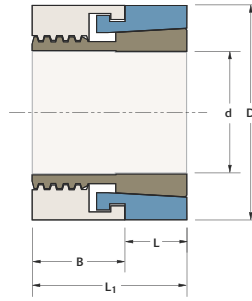
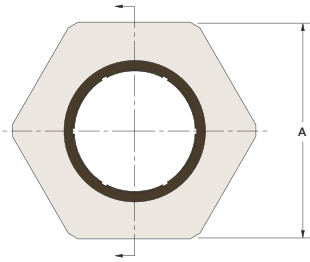

TOLERANCE (T<sub>L</sub>)

Bore diameter machined to  $D \pm T_L$

T<sub>L</sub> = .0015" for Part Numbers

6940103 - 6940119

T<sub>L</sub> = .003" for all other Trantorque S

Trantorque S Inch

Part Number	d (inch)	D (inch)	L (inch)	L <sub>1</sub> (inch)	Wrench Size		M <sub>a</sub> Install Torque (in lb)	M <sub>t</sub> Maximum Transmitted Torque (ft lb)	T <sub>h</sub> Thrust (lbs)	P <sub>h</sub> Hub Pressure (psi)	DN* Minimum Hub Diameter (inch)
					A (inch)	B (inch)					
6940103	3/16	5/8	1/4	5/8	5/8	3/8	125	8	700	7800	0.745
6940105	1/4	5/8	1/4	5/8	5/8	3/8	125	13	790	7800	0.745
6940107	5/16	3/4	1/4	5/8	3/4	3/8	150	17	890	6475	0.867
6940109	3/8	3/4	1/4	5/8	3/4	3/8	150	21	925	6475	0.867
6940110	7/16	7/8	3/8	3/4	7/8	3/8	175	25	950	3600	0.948
6940112	1/2	7/8	3/8	3/4	7/8	3/8	175	29	980	3600	0.948
6940114	9/16	1	3/8	7/8	1	1/2	200	33	990	3000	1.069
6940115	5/8	1	3/8	7/8	1	1/2	200	38	1000	3000	1.069
6940119	3/4	1 1/4	3/8	1	1 1/4	5/8	700	125	2000	16000	1.813
6940120	5/8	1 1/2	1/2	1 1/4	1 1/2	3/4	1200	146	3300	16500	2.203
6940140	11/16	1 1/2	1/2	1 1/4	1 1/2	3/4	1200	167	3850	16500	2.203
6940160	3/4	1 1/2	1/2	1 1/4	1 1/2	3/4	1200	208	4400	16500	2.203
6940190	13/16	1 3/4	1/2	1 1/4	1 3/4	3/4	1500	217	4950	16450	2.567
6940200	7/8	1 3/4	1/2	1 1/4	1 3/4	3/4	1500	233	5500	16450	2.567
6940220	15/16	1 3/4	1/2	1 1/4	1 3/4	3/4	1500	258	6050	16450	2.567
6940240	1	1 3/4	1/2	1 1/4	1 3/4	3/4	1500	292	6600	16450	2.567
6940270	1 1/16	2	1/2	1 1/4	2	3/4	2000	333	7000	15600	2.871
6940280	1 1/8	2	1/2	1 1/4	2	3/4	2000	383	7500	15600	2.871
6940300	1 3/16	2	1/2	1 1/4	2	3/4	2000	433	8000	15600	2.871
6940320	1 1/4	2	1/2	1 1/4	2	3/4	2000	500	8500	15600	2.871
6940350	1 5/16	2 3/8	1/2	1 1/2	2 1/4	1	2300	517	9000	19500	3.777
6940360	1 3/8	2 3/8	1/2	1 1/2	2 1/4	1	2300	533	9500	19500	3.777
6940380	1 7/16	2 3/8	1/2	1 1/2	2 1/4	1	2300	558	10000	19500	3.777
6940400	1 1/2	2 3/8	1/2	1 1/2	2 1/4	1	2300	583	10500	19500	3.777
6940430	1 9/16	2 5/8	1/2	1 1/2	2 1/2	1	2800	667	11000	18565	4.071
6940440	1 5/8	2 5/8	1/2	1 1/2	2 1/2	1	2800	708	11750	18565	4.071
6940460	1 11/16	2 5/8	1/2	1 1/2	2 1/2	1	2800	771	12250	18565	4.071
6940480	1 3/4	2 5/8	1/2	1 1/2	2 1/2	1	2800	833	12750	18565	4.071

\*Required hub OD for 1045 h.r. steel hub assuming 45 ksi Yield Point and Stress Reduction Factor C=1 (see page 16 for details)  
Consult factory for weights and availability.

## DESIGN FEATURES

External locking devices for keyless frictional shaft/hub connections on shafts from 5/8" to 40" diameter, B-LOC Shrink Discs...

- Provide a high capacity interference fit with all the positive features of conventional interference fits, but without their assembly and dismounting problems.
- Offer extremely concentric and well-balanced connections, ideal for high-speed applications.
- Permit simple axial and angular timing.
- Are available in standard, light, and heavy-duty series to suit any application.

## WORKING PRINCIPLE

The double tapered inner ring of a B-LOC Shrink Disc provides a high-ratio conversion of screw clamp loads into radial contact pressures when the outer collars are pulled together by tightening of the integrated high-strength locking screws. These radial contact pressures in turn accomplish the following:

1. Contract the inner ring and hub to bridge the clearance between shaft and hub bore.
2. Generate a defined shaft/hub contact pressure for a high capacity mechanical interference fit.

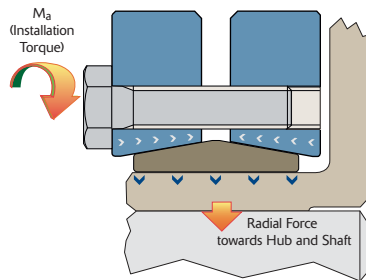

This frictional bond transmits torque, bending and/or thrust loads directly from the hub to the shaft; the shrink disc itself does not carry any torque or thrust load.

## TORQUE

$M_t$  = rated torque capacity of one B-LOC Shrink Disc with all screws tightened to specified torque  $M_a$  as listed in specifications, based on a coefficient of friction  $\mu = 0.15$  and specified tolerances and clearances. Torque capacities for Half Shrink Discs =  $\frac{M_t}{2}$

- Torque capacities for connections using shaft diameters between the minimum and maximum sizes listed can be approximated through interpolation.
- Transmissible torque decreases if tolerances and/or clearances are larger than specified; or if hollow shafts with bores exceeding 35% of shaft diameter are used.

## THRUST

$T_h$  = transmissible thrust, determined by using the following equation:

$$T_h = \frac{2 \times M_t}{d}$$

where:  $d$  = shaft diameter

$M_t$  = unit torque rating

## TORQUE AND THRUST COMBINED

Simultaneous transmission of torque and thrust requires calculating a resultant torque:

$$M_{t_{res}} = \sqrt{T^2 + \left(\frac{F \times d}{2}\right)^2}$$

where:  $T$  = peak drive torque

$F$  = peak thrust load

$d$  = shaft diameter

Select a unit where  $M_t \geq M_{t_{res}}$ .

## BENDING MOMENTS

Shrink discs will generally transmit a continuous bending moment equal to 25% of rated torque capacity  $M_t$ .

## RELEASEABILITY

Since the tapers of a B-LOC Shrink Disc are self-releasing and stresses from radial contractions of the hub are well within elastic limits, relaxing of the locking screws results in hub expansion back to its original dimensions, thereby restoring fit clearance for simple disassembly.

## MATERIAL

Shrink disc inner rings are manufactured from high-carbon steel. Outer rings are made from forged and heat treated alloy steel.

## LUBRICANTS

Shrink discs are supplied with Molybdenum Disulphide based lubricant applied to the tapers and to the locking screw threads and head contact areas.

## SHAFT AND HUB MATERIAL

Listed specifications assume shaft and hub material with a yield point of at least 45,000 psi. Cast iron hubs are well suited for compressive stresses exerted by B-LOC Shrink Discs. However, a lower torsional hub strength generally requires the selection of a shrink disc at least one size larger than listed if full torque (i.e., that applicable to a steel hub) is to be transmitted.

## LENGTH OF FIT

The most recent research on length of fit for a shrink disc connection\* indicates that the hub bore-to-shaft interface should be relieved using a non-toleranced clearance except for that portion directly under the shrink disc inner ring, for a fit length equal to "L" for a standard shrink disc (see illustration at right). This approach eliminates fretting corrosion between shaft and hub which can make the separation of components difficult.

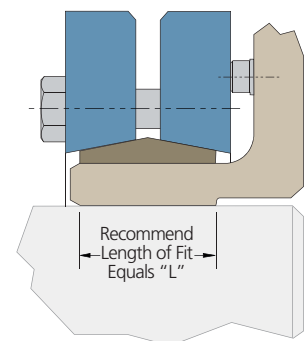

\* (see Casper, Thomas: Reibkorrosionsverhalten von Spänlementverbindungen - Aachen: Mainz, 1999)

## LOCATING AGAINST HUB FACE

In applications subjected to reversing bending moments, we recommend the configuration at right which requires a hub undercut where  $R \geq e$  for smooth transition.

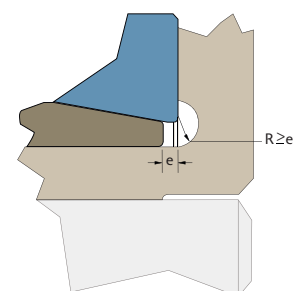

# Shrink Disc SD10



Metric hex head locking screws  
DIN 931 grade 10.9  
(See  $M_a$  for install torque).

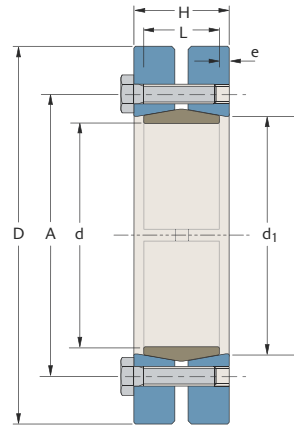

Note: See table (below right) for maximum diametrical clearance between shaft and hub bore.

## SD10 – Standard Duty

Part Number	Size	SD bore (Hub OD) Tolerance		Shaft Diameter Range		Locking Screws		$M_a$ Install Torque (ft lb)	$M_t$ Max. Transmitted Torque		A (inch)	D (inch)	L (inch)	H (inch)	e (inch)	$d_1$ (inch)	a (inch)	R (inch)	Ship wt (lb)
		d (inch)	$T_d$ (inch)	ds-MIN (inch)	ds-MAX (inch)	Qty	Size		ds-MIN (ft lb)	ds-MAX (ft lb)									
B0241	24-10	0.945	+ 0 / -0.002	5/8	0.774	6	M5 x 16	3.6	138	278	1.417	1.97	0.551	0.71	0.080	1.023	0.098	1/16	0.5
B0301	30-10	1.181	+ 0 / -0.002	3/4	0.967	7	M5 x 18	3.6	177	407	1.732	2.36	0.629	0.79	0.081	1.259	0.098	1/16	0.7
B0361	36-10	1.417	+ 0 / -0.002	7/8	1.161	5	M6 x 20	8.7	315	666	2.047	2.83	0.700	0.87	0.085	1.496	0.098	1/16	0.9
B0441	44-10	1.732	+ 0 / -0.002	1 1/8	1.419	7	M6 x 20	8.7	683	1198	2.402	3.15	0.787	0.94	0.077	1.850	0.098	1/16	1.4
B0501	50-10	1.969	+ 0 / -0.002	1 3/8	1.612	8	M6 x 22	8.7	964	1565	2.756	3.54	0.866	1.02	0.077	2.086	0.098	1/16	1.8
B0551	55-10	2.165	+ 0 / -0.002	1 1/2	1.773	8	M6 x 25	8.7	1014	1707	2.953	3.94	0.905	1.14	0.118	2.283	0.098	3/32	2.4
B0621	62-10	2.441	+ 0 / -0.002	1 3/4	1.999	10	M6 x 25	8.7	1718	2375	3.386	4.33	0.905	1.14	0.118	2.598	0.098	3/32	2.9
B0681	68-10	2.677	+ 0 / -0.002	1 7/8	2.193	10	M6 x 25	8.7	1760	2606	3.386	4.53	0.905	1.14	0.118	2.834	0.098	3/32	3.0
B0751	75-10	2.953	+ 0 / -0.002	2 1/8	2.418	7	M8 x 25	22	2792	4057	3.937	5.43	0.984	1.22	0.118	3.110	0.197	1/8	3.8
B0801	80-10	3.150	+ 0 / -0.002	2 3/8	2.580	7	M8 x 25	22	3416	4331	3.937	5.71	0.984	1.22	0.118	3.307	0.197	1/8	4.2
B0901	90-10	3.543	+ 0 / -0.004	2 1/2	2.902	10	M8 x 30	22	4751	7139	4.488	6.10	1.181	1.49	0.155	3.700	0.197	1/8	7
H0951	95-10	3.740	+ 0 / -0.004	2 3/4	3.063	12	M8 x 30	22	6832	9108	4.882	6.69	1.338	1.69	0.176	4.094	0.197	1/8	10
B1001	100-10	3.937	+ 0 / -0.004	2 7/8	3.224	12	M8 x 35	22	7059	9586	4.882	6.69	1.338	1.69	0.176	4.094	0.197	1/8	10
B1101	110-10	4.331	+ 0 / -0.004	3 1/8	3.547	9	M10 x 40	44	9013	12602	5.354	7.28	1.535	1.93	0.198	4.488	0.197	1/8	13
B1251	125-10	4.921	+ 0 / -0.004	3 1/2	4.031	12	M10 x 40	44	13710	19540	6.299	8.46	1.653	2.04	0.194	5.275	0.197	1/8	18
B1401	140-10	5.512	+ 0 / -0.004	4	4.514	10	M12 x 45	74	19648	26440	6.890	9.06	1.811	2.28	0.235	5.708	0.197	3/16	23
B1551	155-10	6.102	+ 0 / -0.004	4 1/2	4.998	12	M12 x 50	74	27515	34049	7.559	10.36	1.968	2.44	0.236	6.496	0.197	3/16	31
H1651	165-10	6.496	+ 0 / -0.004	4 7/8	5.320	8	M16 x 55	185	37737	47135	8.268	11.42	2.204	2.67	0.233	6.889	0.197	3/16	49
B1751	175-10	6.890	+ 0 / -0.004	5 1/4	5.643	8	M16 x 55	185	41620	50005	8.661	11.81	2.204	2.67	0.233	7.283	0.197	3/16	50
B1851	185-10	7.283	+ 0 / -0.004	5 5/8	5.965	10	M16 x 65	185	56802	65965	9.291	12.99	2.795	3.34	0.273	7.677	0.197	3/16	82
H1951	195-10	7.677	+ 0 / -0.004	5 7/8	6.288	12	M16 x 65	185	71908	84926	9.685	13.78	2.795	3.34	0.273	8.110	0.197	3/16	91
B2001	200-10	7.874	+ 0 / -0.004	6 1/4	6.449	12	M16 x 65	185	80674	87096	9.685	13.78	2.795	3.34	0.273	8.110	0.197	3/16	90
B2201	220-10	8.661	+ 0 / -0.004	6 3/8	7.094	15	M16 x 80	185	92230	116425	10.630	14.57	3.464	4.06	0.298	8.897	0.295	1/4	119
B2401	240-10	9.449	+ 0 / -0.004	7	7.739	12	M20 x 80	362	130645	161818	11.614	15.95	3.622	4.22	0.299	9.763	0.295	1/4	148
B2601	260-10	10.236	+ 0 / -0.004	7 5/8	8.383	14	M20 x 90	362	162198	205263	12.638	16.93	4.055	4.69	0.318	10.511	0.295	1/4	181
H2801	280-10	11.024	+ 0 / -0.005	8 3/8	9.028	16	M20 x 100	362	210581	253378	13.622	18.11	4.488	5.20	0.356	11.338	0.394	5/16	225
H3001	300-10	11.811	+ 0 / -0.005	9	9.673	18	M20 x 100	362	257278	306749	14.331	19.10	4.803	5.52	0.359	12.125	0.394	5/16	260
H3201	320-10	12.598	+ 0 / -0.005	9 5/8	10.318	20	M20 x 100	362	310492	359728	15.197	20.48	4.803	5.52	0.359	12.913	0.394	5/16	288
H3401	340-10	13.386	+ 0 / -0.005	10 1/4	10.963	24	M20 x 110	362	392088	462391	16.063	22.44	5.276	6.14	0.432	13.700	0.394	5/16	409
H3501	350-10	13.780	+ 0 / -0.005	10 7/8	11.285	24	M20 x 110	362	432685	474097	17.008	22.84	5.511	6.30	0.395	14.488	0.394	5/16	429
H3601	360-10	14.173	+ 0 / -0.005	11 1/4	11.608	24	M20 x 110	362	451405	487702	17.008	23.23	5.511	6.30	0.395	14.488	0.394	5/16	449
H3801	380-10	14.961	+ 0 / -0.005	11 1/2	12.253	20	M24 x 120	620	535005	623051	18.031	25.40	5.669	6.46	0.396	15.276	0.394	5/16	526
H3901	390-10	15.354	+ 0 / -0.005	12 1/4	12.575	21	M24 x 120	620	633184	673847	18.425	25.99	5.669	6.46	0.396	15.629	0.492	3/8	572
H4201	420-10	16.535	+ 0 / -0.006	12 1/2	13.543	24	M24 x 130	620	685493	829666	19.843	27.17	6.456	7.25	0.397	16.929	0.492	3/8	630
H4401	440-10	17.323	+ 0 / -0.006	13 1/2	14.187	24	M24 x 130	620	768743	852536	20.748	29.53	6.771	7.56	0.395	17.716	0.492	3/8	835
H4601	460-10	18.110	+ 0 / -0.006	14 1/8	14.832	24	M24 x 130	620	789383	891308	21.535	30.32	6.771	7.56	0.395	18.425	0.492	3/8	924
H4801	480-10	18.898	+ 0 / -0.006	14 3/4	15.477	30	M24 x 150	620	1047086	1176357	22.441	31.50	7.401	8.39	0.495	19.291	0.591	1/2	1110
H5001	500-10	19.685	+ 0 / -0.006	15 3/8	16.122	24	M27 x 150	922	1169590	1310148	23.228	33.46	7.401	8.39	0.495	19.999	0.591	1/2	1265

### Specifications for Web Clearance Holes (diameter in inches)

Screw Size	M5	M6	M8	M10	M12	M16	M20	M24	M27
Split Shrink Disc	0.281	0.328	0.406	0.500	0.594	0.750	0.906	1.063	1.188
Half Shrink Disc HT	0.219	0.266	0.359	0.438	0.531	0.719	0.875	1.031	1.156

### Notes:

- Inner rings of all shrink discs are supplied with one lengthwise slit.
- Shrink discs are available for shafts up to 40" diameter and in a variety of special designs.
- Maximum shaft sizes listed for Series 10 and Series 30 Shrink Discs reflect equal section moduli of shaft and hub (maximum shaft diameter =  $\frac{d}{1.221}$ ).

	Shaft Sizes (inch)		Maximum Diametrical Clearance Between Shaft and Hub Bore
	>	≤	
	1 1/8		0.0010
1 1/8		1 15/16	0.0015
1 15/16	4 3/4		0.0020
4 3/4		7	0.0030
7		10	0.0040
10		14	0.0050
14			0.0060

NOTE: Larger shrink discs for shafts up to 40" diameter are available on request.

# Shrink Disc SD20 SD30

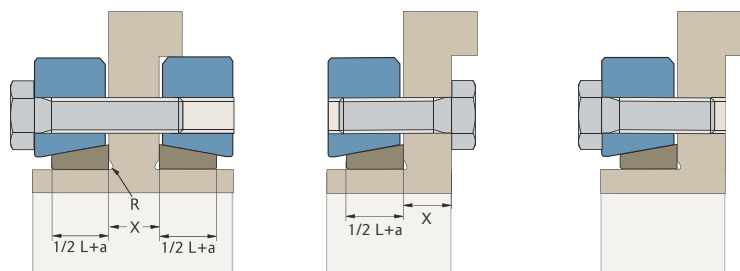

Note: Dimension X is required when ordering Split or Half Shrink Disc Type HT. See table at bottom left of facing page for web clearance hole data.

Split Shrink Disc

Half Shrink Disc  
Type HT

Half Shrink Disc  
Type HC

## SD20 – Light Duty

Part Number	Size	SD bore (Hub OD) Tolerance		Shaft Diameter Range		Locking Screws		M <sub>a</sub> Install Torque (ft lb)	M <sub>t</sub> Max. Transmitted Torque		A (inch)	D (inch)	L (inch)	H (inch)	e (inch)	d <sub>1</sub> (inch)	a (inch)	R (inch)	Ship wt (lb)
		d (inch)	T <sub>d</sub> (inch)	ds-MIN (inch)	ds-MAX (inch)	Qty	Size		ds-MIN (ft lb)	ds-MAX (ft lb)									
		H1252	125-20	4.921	+ 0 / -0.004	3 5/8	4.125		8	M10 x 40									
H1402	140-20	5.512	+ 0 / -0.004	4 1/4	5.000	10	M10 x 40	44	15457	22768	6.889	8.67	1.535	2.05	0.258	5.669	0.197	1/8	18
H1552	155-20	6.102	+ 0 / -0.004	5	5.500	12	M10 x 40	44	23344	30111	7.559	9.65	1.535	2.05	0.258	6.259	0.197	1/8	22
H1652	165-20	6.496	+ 0 / -0.004	5 3/8	5.750	10	M12 x 50	74	30652	36677	8.267	10.24	1.811	2.44	0.315	6.653	0.197	3/16	31
H1752	175-20	6.890	+ 0 / -0.004	5 5/8	6.125	10	M12 x 50	74	31363	39348	8.661	10.83	1.811	2.44	0.315	7.047	0.197	3/16	35
H1852	185-20	7.283	+ 0 / -0.004	6	6.500	12	M12 x 50	74	41643	51035	8.858	11.62	1.811	2.44	0.315	7.440	0.197	3/16	44
H1952	195-20	7.677	+ 0 / -0.004	6 1/2	7.000	15	M12 x 60	74	58979	71073	9.330	12.40	2.204	2.84	0.318	7.834	0.197	3/16	60
H2202	220-20	8.661	+ 0 / -0.004	7	7.875	10	M16 x 70	185	76454	100895	10.433	13.59	2.598	3.31	0.356	8.818	0.197	3/16	77
H2402	240-20	9.449	+ 0 / -0.004	7 7/8	8.500	12	M16 x 70	185	107011	129864	11.417	14.57	2.598	3.31	0.356	9.606	0.295	1/4	97
H2602	260-20	10.236	+ 0 / -0.004	8 5/8	9.250	12	M16 x 70	185	118200	141618	12.204	15.55	2.834	3.63	0.398	10.433	0.295	1/4	106
H2802	280-20	11.024	+ 0 / -0.005	9	9.875	16	M16 x 75	185	158724	200396	13.110	16.74	3.307	4.10	0.397	11.220	0.295	1/4	132
H3002	300-20	11.811	+ 0 / -0.005	9 7/8	10.625	18	M16 x 75	185	205242	242683	14.094	18.11	3.307	4.10	0.397	12.007	0.295	1/4	165
H3202	320-20	12.598	+ 0 / -0.005	10 1/2	11.375	18	M16 x 75	185	212736	261299	14.881	19.49	3.307	4.18	0.437	12.795	0.295	1/4	185
H3402	340-20	13.386	+ 0 / -0.005	11 3/8	12.000	20	M16 x 75	185	266514	304738	15.826	21.07	3.307	4.18	0.437	13.582	0.295	1/4	220
H3602	360-20	14.173	+ 0 / -0.005	11 7/8	12.625	16	M20 x 90	362	341876	398029	16.653	21.85	3.937	4.81	0.437	14.370	0.394	5/16	275
H3802	380-20	14.961	+ 0 / -0.005	12 1/2	13.000	18	M20 x 100	362	403340	444630	17.401	23.03	4.409	5.35	0.471	15.236	0.394	5/16	301
H3902	390-20	15.354	+ 0 / -0.005	12 5/8	13.750	20	M20 x 100	362	446171	549086	17.795	23.43	4.409	5.36	0.476	15.629	0.394	5/16	344
H4202	420-20	16.535	+ 0 / -0.006	13 3/4	14.625	20	M20 x 100	362	491043	565312	19.094	24.81	4.724	5.67	0.473	16.810	0.394	5/16	407
H4602	460-20	18.110	+ 0 / -0.006	14 5/8	16.375	24	M20 x 110	362	594102	789533	20.747	26.97	5.196	6.22	0.512	18.425	0.492	3/8	517
H5002	500-20	19.685	+ 0 / -0.006	16 1/4	17.375	30	M20 x 120	362	860127	1014952	22.519	29.53	5.984	7.01	0.513	19.999	0.492	3/8	704

## SD30 – Heavy Duty

Part Number	Size	SD bore (Hub OD) Tolerance		Shaft Diameter Range		Locking Screws		M <sub>a</sub> Install Torque (ft lb)	M <sub>t</sub> Max. Transmitted Torque		A (inch)	D (inch)	L (inch)	H (inch)	e (inch)	d <sub>1</sub> (inch)	a (inch)	R (inch)	Ship wt (lb)
		d (inch)	T <sub>d</sub> (inch)	ds-MIN (inch)	ds-MAX (inch)	Qty	Size		ds-MIN (ft lb)	ds-MAX (ft lb)									
		H0443	44-30	1.732	+ 0 / -0.002	1 1/8	1.419		5	M8 x 30									
H0503	50-30	1.969	+ 0 / -0.002	1 3/8	1.612	7	M8 x 35	22	1761	2749	2.874	3.74	1.181	1.54	0.177	2.126	0.098	1/16	1.8
H0553	55-30	2.165	+ 0 / -0.002	1 1/2	1.773	7	M8 x 35	22	1892	3023	3.071	4.13	1.181	1.54	0.177	2.323	0.098	3/32	2.4
B0623	62-30	2.441	+ 0 / -0.002	1 3/4	1.999	7	M8 x 35	22	2353	3244	3.346	4.53	1.181	1.54	0.177	2.598	0.098	3/32	2.9
B0683	68-30	2.677	+ 0 / -0.002	1 7/8	2.193	8	M8 x 35	22	2861	4173	3.622	4.72	1.181	1.54	0.177	2.835	0.098	3/32	3.0
B0753	75-30	2.953	+ 0 / -0.002	2 1/8	2.418	7	M10 x 40	44	4552	6529	4.134	5.71	1.417	1.81	0.197	3.307	0.197	1/8	3.8
B0803	80-30	3.150	+ 0 / -0.002	2 3/8	2.580	7	M10 x 40	44	5541	6971	4.134	5.71	1.417	1.81	0.197	3.307	0.197	1/8	4.2
B0903	90-30	3.543	+ 0 / -0.004	2 1/2	2.902	8	M10 x 40	44	5946	8994	4.567	6.30	1.575	1.97	0.197	3.701	0.197	1/8	7
B1003	100-30	3.937	+ 0 / -0.004	2 7/8	3.224	10	M10 x 45	44	9370	12700	4.961	6.69	1.732	2.13	0.197	4.094	0.197	1/8	10
H1103	110-30	4.331	+ 0 / -0.004	3 1/8	3.547	14	M10 x 45	44	14352	19862	5.354	7.28	2.126	2.60	0.237	4.482	0.197	1/8	17
H1253	125-30	4.921	+ 0 / -0.004	3 1/2	4.031	12	M12 x 50	74	20092	28393	6.299	8.47	2.126	2.60	0.237	5.157	0.197	3/16	24
B1403	140-30	5.512	+ 0 / -0.004	4	4.514	12	M12 x 60	74	23275	31491	6.889	9.06	2.362	2.92	0.279	5.744	0.197	3/16	29
H1553	155-30	6.102	+ 0 / -0.004	4 1/2	4.998	15	M12 x 60	74	34154	42273	7.795	10.36	2.598	3.15	0.276	6.496	0.197	3/16	44
H1653	165-30	6.496	+ 0 / -0.004	4 7/8	5.320	10	M16 x 70	185	46957	58743	8.267	11.42	2.834	3.47	0.318	6.940	0.197	3/16	57
H1753	175-30	6.890	+ 0 / -0.004	5 1/4	5.643	10	M16 x 70	185	51804	62320	8.661	11.82	2.834	3.47	0.318	7.322	0.197	3/16	64
H1853	185-30	7.283	+ 0 / -0.004	5 5/8	5.965	15	M16 x 80	185	86847	100371	9.291	12.99	3.622	4.41	0.394	7.704	0.197	3/16	104
H1953	195-30	7.677	+ 0 / -0.004	5 7/8	6.288	15	M16 x 80	185	89488	105820	9.685	13.78	3.622	4.41	0.394	8.102	0.295	1/4	110
H2003	200-30	7.874	+ 0 / -0.004	6 1/4	6.449	15	M16 x 80	185	100466	108524	9.685	13.78	3.622	4.41	0.394	8.102	0.295	1/4	110
H2203	220-30	8.661	+ 0 / -0.004	6 3/8	7.094	20	M16 x 90	185	123458	155750	10.629	14.57	4.488	5.28	0.396	8.901	0.295	1/4	143
B2403	240-30	9.449	+ 0 / -0.004	7	7.739	15	M20 x 100	362	162518	201425	11.614	15.95	4.724	5.67	0.473	9.692	0.295	1/4	192
H2603	260-30	10.236	+ 0 / -0.005	7 5/8	8.383	18	M20 x 110	362	207733	263252	12.637	16.93	5.354	6.30	0.473	10.511	0.295	1/4	220
H2803	280-30	11.024	+ 0 / -0.005	8 3/8	9.028	20	M20 x 120	362	261931	315635	13.622	18.11	5.826	6.77	0.472	11.370	0.394	5/16	291
H3003	300-30	11.811	+ 0 / -0.005	9	9.673	20	M20 x 120	362	281727	337340	14.330	19.10	5.984	6.93	0.473	12.177	0.394	5/16	308
H3203	320-30	12.598	+ 0 / -0.005	9 5/8	10.318	24	M20 x 120	362	368957	427823	15.196	20.48	6.299	7.25	0.476	12.964	0.394	5/16	363
H3403	340-30	13.386	+ 0 / -0.005	10 1/4	10.963	20	M24 x 130	620	462964	547814	16.535	22.44	6.929	7.88	0.476	13.724	0.394	5/16	528
H3603	360-30	14.173	+ 0 / -0.005	11	11.608	20	M24 x 140	620	505604	578783	17.007	23.23	7.086	8.04	0.477	14.515	0.492	3/8	550
H3903	390-30	15.354	+ 0 / -0.005	11 5/8	12.575	24	M24 x 140	620	628949	762028	18.425	25.99	7.401	8.35	0.475	15.787	0.492	3/8	770
H4203	420-30	16.535	+ 0 / -0.006	12 1/2	13.543	30	M24 x 160	620	852841	1033732	19.842	27.17	8.425	9.37	0.472	16.811	0.492	3/8	902
H4603	460-30	18.110	+ 0 / -0.006	13 5/8	14.832	28	M27 x 170	922	1144559	1403894	21.535	30.32	8.818	9.93	0.556	18.503	0.591	1/2	1188
H5003	500-30	19.685	+ 0 / -0.006	14 7/8	16.122	32	M27 x 180	922	1443359	1749331	23.228	33.47	9.685	10.79	0.552	19.999	0.591	1/2	1650

# B-LOC WK SERIES



### TOLERANCE ( $T_L$ )

$T_L = .003"$  for shafts up to 1"  
.006" for shafts over 1"

$d$  = Shaft diameter machined to  $d+0/-T_L$

Metric hex head locking screws grade 10.9. (See  $M_a$  for install torque.)

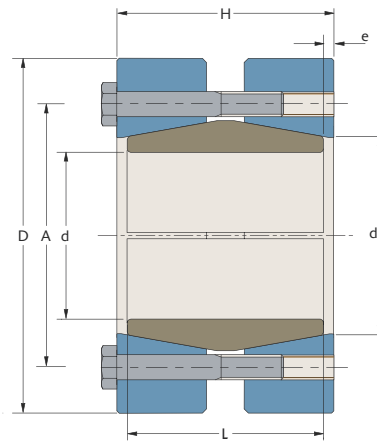

Note: Shaft engagement equal for both ends with gap not exceeding 5% of shaft diameter.

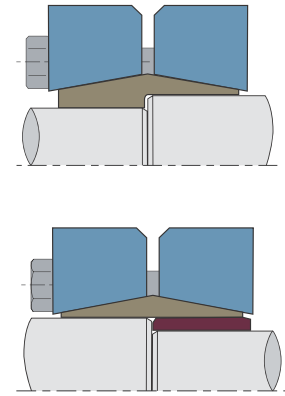

WK Couplings can be manufactured to accommodate different shaft diameters; this can also be accomplished using an adaptor sleeve.

## WK Series

Part Number	Type	d (in)	D (in)	H (in)	L (in)	e (in)	d <sub>1</sub> (in)	A (in)	Locking Screws		M <sub>a</sub> Install Torque (ft lb)	M <sub>t</sub> Maximum Transmissible Torque (ft lb)	Ship wt (lb)
									Qty	Size			
HWK0152010	WK 15-12	5/8	2.047	1.339	1.181	0.079	0.827	1.378	3	M6 x 30	8.7	132	0.9
HWK0152011		11/16										145	0.9
HWK0152012		3/4										158	0.9
HWK0202013	WK 20-12	13/16	2.362	1.575	1.339	0.118	1.024	1.614	5	M6 x 35	8.7	286	1.4
HWK0202014		7/8										308	1.3
HWK0202015		15/16										330	1.3
HWK0252100	WK 25-12	1	2.598	1.732	1.496	0.118	1.260	1.890	7	M6 x 35	8.7	492	1.8
HWK0252101		1 1/16										523	1.8
HWK0252102		1 1/8										554	1.7
HWK0302103	WK 30-12	1 3/16	2.992	1.890	1.654	0.118	1.496	2.126	8	M6 x 40	8.7	668	2.7
HWK0302104		1 1/4										703	2.7
HWK0302106		1 3/8										774	2.6
HWK0402107	WK 40-12	1 7/16	3.780	2.205	1.969	0.118	1.850	2.638	7	M8 x 45	22	1371	5
HWK0402108		1 1/2										1430	5
HWK0402110		1 5/8										1550	5
HWK0402111		1 11/16										1609	5
HWK0402112		1 3/4										1669	5
HWK0502114	WK 50-12	1 7/8	4.409	2.676	2.362	0.157	2.283	3.150	10	M8 x 50	22	2554	8
HWK0502115		1 15/16										2639	8
HWK0502200		2										2724	8
HWK0502202		2 1/8										2895	8
HWK0602203	WK 60-12	2 3/16	4.724	3.071	2.756	0.157	2.598	3.504	12	M8 x 55	22	3576	10
HWK0602204		2 1/4										3678	10
HWK0602206		2 3/8										3882	10
HWK0602207		2 7/16										3984	10
HWK0602208		2 1/2										4087	9
HWK0702209	WK 70-12	2 9/16	5.826	3.464	3.150	0.157	3.110	4.173	12	M10 x 65	44	6642	19
HWK0702210		2 5/8										6804	19
HWK0702211		2 11/16										6966	18
HWK0702212		2 3/4										7128	18
HWK0702214		2 7/8										7452	17
HWK0802215	WK 80-12	2 15/16	6.693	4.095	3.701	0.197	3.701	4.961	10	M12 x 80	74	9128	28
HWK0802300		3										9323	28
HWK0802302		3 1/8										9711	27
HWK0802304		3 1/4										10099	26
HWK0802306		3 3/8										10488	26
HWK0902307	WK 90-12	3 7/16	7.283	4.567	4.173	0.197	4.094	5.433	12	M12 x 80	74	12819	36
HWK0902308		3 1/2										13052	36
HWK0902310		3 5/8										13518	35
HWK0902312		3 3/4										13984	34
HWK0902314		3 7/8										14450	34
HWK1002315	WK 100-12	3 15/16	7.756	4.960	4.488	0.236	4.488	5.866	15	M12 x 90	74	18354	43
HWK1002400		4										18645	43
HWK1002404		4 1/4										19810	42

NOTE: If your application requires increased torque transmission and/or thrust, solvent clean the interface between the bore of the WK unit and the shaft to produce an oil free connection. This in turn will result in up to a 20% increase in  $M_t$  and  $T_h$  performance values. Contact Fenner Drives Applications Engineering for additional details.



## B-LOC SINGLE TAPER SHRINK DISCS

As an alternative to Series 10, 20 & 30 Shrink Discs (Double Taper Shrink Discs), we can offer Single Taper Shrink Discs upon request. These units have the following attributes:

- External locking device
- Simpler two piece design
- Integrated removal holes (depending on the particular unit, product may be self-locking or self-releasing)
- Provides extremely concentric and well-balanced mechanical interference fit

Single Taper Shrink Discs are available in Light, Standard and Heavy Duty Series. Dynamic fit pressures vary between Single Taper and Double Taper shrink discs, as this is based on effective contact length. This should be taken into consideration.

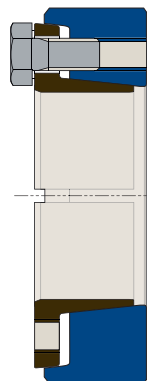

## B-LOC RIGID SHRINK DISC COUPLINGS

B-LOC Shrink Discs are perfect for creating custom rigid shaft couplings that transmit high torque and/or bending loads. Due to their high load capacities, B-LOC Shrink Disc couplings are frequently used to shaft-mount hydraulic drives and speed reducers. This design solution:

- Can easily accommodate different sized shafts.
- Results in a zero backlash interference fit that will never wear out or pound out, even when subjected to repeated shock or reversing loads.
- Eliminates the need for support structures or foundations, since the drive/reducer is mounted directly to the shaft.
- Eliminates the need for costly flexible couplings, since shaft misalignment issues disappear.
- Facilitates quick and easy coupling mounting and disassembly, even in field installations.
- Permits infinite radial and axial adjustment.

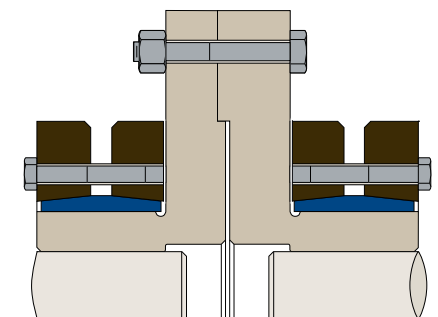

Flange-type Shrink Disc Coupling

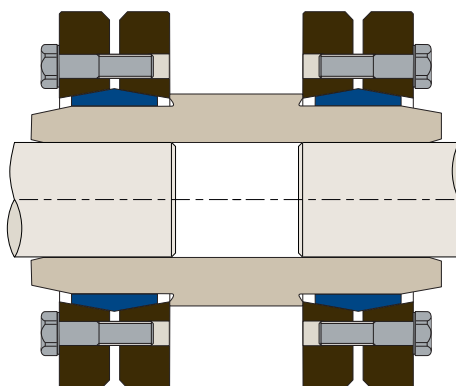

Sleeve-type Shrink Disc Coupling

**Please contact our Applications Engineering Group at +1-800-243-3374 or [ae@fennerdrives.com](mailto:ae@fennerdrives.com) for more information on B-LOC Single Taper Shrink Discs or Rigid Shrink Disc Couplings.**

# Trantorque Installation Wrenches

Fenner Drives offers a complete line of high-quality crowfoot wrenches for use in the installation of Trantorque units. When installing a Trantorque GT, Trantorque EN or Trantorque SS unit, we recommend also using the U style for counter-torque.

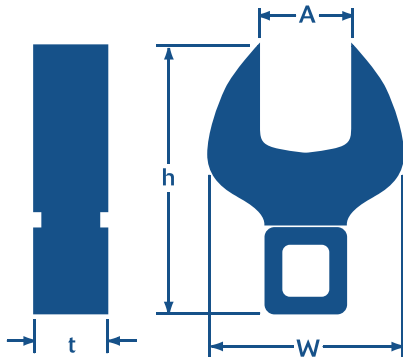

Style C  
Installation Nut

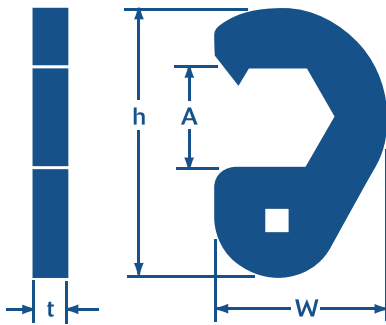

Style G  
Installation Nut

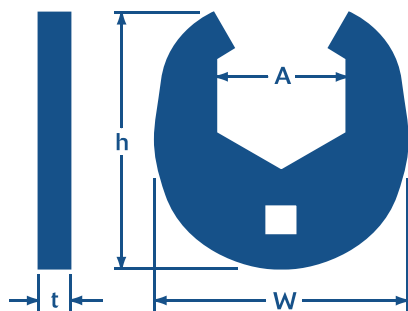

Style U  
Counter-Torque

## 1/2" Square Drive

Part Number	Shaft Size (inches)	Wrench Style	Dimensions (inches)			
			A	h	w	t
6202990020	5/8 – 3/4	C	1 1/4	2.88	2.25	0.60
6202990024U	5/8 – 3/4	U	1 1/2	4.91	4.88	0.31
6202990024	13/16 – 1	C	1 1/2	3.44	2.75	0.75
6202990028U	13/16 – 1	U	1 3/4	4.94	5.13	0.38
6202990028	1 1/16 – 1 1/4	C	1 3/4	3.50	3.25	0.52
6202990032U	1 1/16 – 1 1/4	U	2	5.68	5.37	0.50
6202990032	1 5/16 – 1 1/2	C	2	3.98	3.57	0.51
6202990038	1 5/16 – 1 1/2	U	2 3/8	5.93	5.75	0.50

## 3/4" Square Drive

Part Number	Shaft Size (inches)	Wrench Style	Dimensions (inches)			
			A	h	w	t
6202990036	1 9/16 – 1 3/4	G	2 1/4	6.64	4.38	0.75
6202990042	1 9/16 – 1 3/4	U	2 5/8	6.16	6.00	0.63
6202990040	1 13/16 – 2	G	2 1/2	6.89	4.63	0.75
6202990046	1 13/16 – 2	U	2 7/8	6.17	6.00	0.75
6202990044	2 1/16 – 2 1/4	G	2 3/4	7.20	4.34	0.75
6202990050	2 1/16 – 2 1/4	U	3 1/8	6.10	6.00	0.75
6202990048	2 5/16 – 2 1/2	G	3	7.88	5.03	0.75
6202990054	2 5/16 – 2 1/2	U	3 3/8	8.00	8.50	0.63
6202990052	2 9/16 – 2 3/4	G	3 1/4	8.57	5.72	0.75
6202990058	2 9/16 – 2 3/4	U	3 5/8	7.11	7.41	0.75
6202990056	2 13/16 – 3	G	3 1/2	9.32	5.72	0.75
6202990062	2 13/16 – 3	U	3 7/8	7.74	7.94	0.75

# Application Data Sheet

Please provide the details for your application on the form below and fax to +1-717-665-2597, email to ae@fennerdrives.com or call +1-800-243-3374. Our Applications Engineering team will review your application data and contact you with product recommendations.

## Contact Information

Company Name \_\_\_\_\_  
Address \_\_\_\_\_  
City \_\_\_\_\_ State \_\_\_\_\_ Zip \_\_\_\_\_ Country \_\_\_\_\_  
Contact \_\_\_\_\_ Title \_\_\_\_\_ Phone \_\_\_\_\_ Fax \_\_\_\_\_  
E-mail \_\_\_\_\_ Web Address \_\_\_\_\_

## Torque/RPM/Application Details

Nominal Running Torque \_\_\_\_\_  
Peak Torque (if known) \_\_\_\_\_  
Type of Prime Mover (motor, engine, etc.) \_\_\_\_\_  
Type of Application (fan, conveyor, etc.) \_\_\_\_\_  
Operating speed (RPM) at proposed connection \_\_\_\_\_  
Input HP \_\_\_\_\_  
Thrust Load \_\_\_\_\_  
Radial Load \_\_\_\_\_

## Shaft Details (solid)

Shaft Diameter  
(nominal/tolerance or actual measured) \_\_\_\_\_  
Surface Material \_\_\_\_\_  
Material (1020 steel, etc.) \_\_\_\_\_  
Useable Length \_\_\_\_\_  
Coatings (zinc, chrome, etc.) \_\_\_\_\_

## Shaft Details (hollow)

Outside Diameter  
(nominal/tolerance or actual measured) \_\_\_\_\_  
Inside Diameter \_\_\_\_\_  
Surface Material \_\_\_\_\_  
Material (1020 steel, etc.) \_\_\_\_\_  
Useable Length \_\_\_\_\_  
Coatings (zinc, chrome, etc.) \_\_\_\_\_

## Mounted Component Details

Mounted Component (sprocket, gear, pulley, lever arm, coupling hub, etc.) \_\_\_\_\_  
Component Material  
(steel, aluminum, etc.) \_\_\_\_\_  
Material Yield Strength \_\_\_\_\_  
Length thru Bore \_\_\_\_\_  
Bore Diameter (if existing) \_\_\_\_\_  
Bore Surface Finish \_\_\_\_\_  
Component Hub Diameter \_\_\_\_\_  
Coatings on shaft and/or component  
(zinc, chrome, etc.) \_\_\_\_\_  
Thrust Load \_\_\_\_\_

## Operating Conditions

Temperature Range \_\_\_\_\_  
Oil/Chemicals \_\_\_\_\_  
Washdown \_\_\_\_\_  
Start/Stops \_\_\_\_\_  
Frequency of assembly/disassembly \_\_\_\_\_

## Commercial Requirements

Quantity Required \_\_\_\_\_  
Annual Usage \_\_\_\_\_

## Plating Requirements

YES  
Type:  Zinc (RoHS Compliant  Yes  No)  
 Electroless Nickel  
 Other  
 No Our standard oil dip will be supplied

## Comments/Attachments

\_\_\_\_\_  
\_\_\_\_\_  
\_\_\_\_\_  
\_\_\_\_\_  
\_\_\_\_\_  
\_\_\_\_\_  
\_\_\_\_\_  
\_\_\_\_\_

# Count on Fenner Drives.

We've got the right product for your application.



**EAGLE**  
POLYURETHANE BELTING & O-RINGS

**PowerTwist Plus**  
V-BELTS

**SUPER T LINK**  
SP WEDGE BELTS

**NUT LINK**  
V-BELTS

**T-MAX**  
BELT & CHAIN TENSIONERS

**PowerMax**  
PULLEYS & IDLERS

**B-LOC**  
KEYLESS BUSHINGS

**Trantorque**  
Keyless Bushings

**Trackstar**  
UHMW BELT & CHAIN GUIDES

Fenner Drives is a proven leader in the design and manufacture of problem-solving power transmission and motion transfer components. Recognized widely for our expertise and innovation in manufacturing technology, we consistently blend reliability, quality and value in our products. Our ISO 9001 certified production facilities are located in Leeds, UK; Manheim, PA; and Wilmington, NC. As part of our commitment to provide unsurpassed technical support and service, we maintain extensive engineering, development and testing facilities.

**Visit us at [www.fennerdrives.com](http://www.fennerdrives.com)**

 **Fenner Drives**  
an ISO 9001 certified company

311 West Stiegel Street  
Manheim, PA 17545-1747

[www.fennerdrives.com](http://www.fennerdrives.com)  
TEL: 800-243-3374  
TEL: 717-665-2421  
FAX: 717-665-2649

Hudson Road  
Leeds, LS9 7DF UK

[www.fennerdrives.com](http://www.fennerdrives.com)  
TEL: +44 (0)870 7577007  
TEL: +44 (0)113 2493486  
FAX: +44 (0)113 2489656

B-LOC® and Trantorque® are registered trademarks of Fenner Drives in the United States and/or other countries. All other brand and product names are trademarks, registered trademarks or service marks of their respective holders.

Information subject to change without prior notification. Visit [www.fennerdrives.com/catalogs](http://www.fennerdrives.com/catalogs) for the most current information.